

# Insulation Sealing Solution For Doors And Windows

Insulation sealing solution for doors and windows includes EPDM foam seals, EPDM solid seals PU foamed seals, PVC seals and TPE seals. Materials provide excellent heat/cold insulation, smoke insulation, acoustic insulation sealing performance for door perimeter and bottom.

**>100 sections**

A selection of over 100 different types insulation seals

**Customizable**

Support for customized materials and shapes



## REPDM SERIES RUBBER SEAL

REPDM series rubber seal is a superior seal material to prevent the heat cold wind noisy moisture gases dust and worm. Product has long-lasting performance and long service life even in harsh environmental conditions. After long time pressing, the material is able to recover its original shape quickly and its sealing effect is maintained.

EPDM foaming rubber

Sound insulation and noise reduction

Energy saving - cold and heat resistance

Weather and aging resistance

Easy installation with strong self-adhesive

Customized designs are available

For all kinds of security door, wooden door and window gaps.

Color is optional brown white black grey



Various models and sizes available



Different lengths in different packages

**REPDM SERIES RUBBER SEAL**

Color is optional brown white black grey

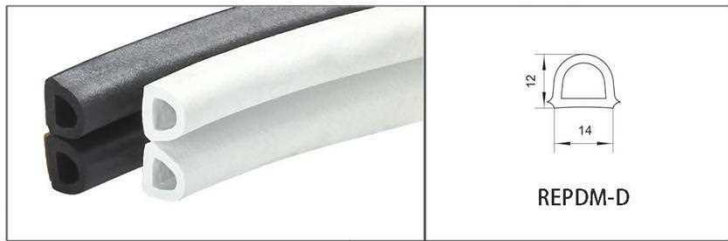
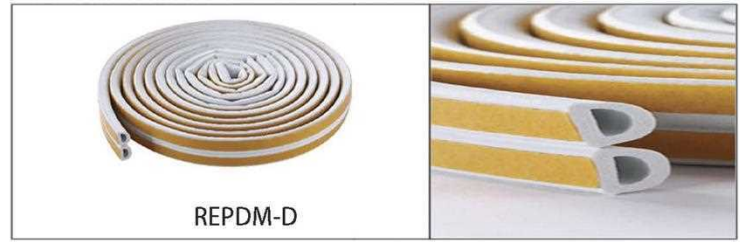

REPDM SERIES RUBBER SEAL

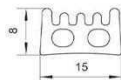

REPDM-E

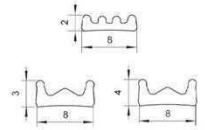

REPDM-E



REPDM-E

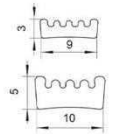

REPDM-E

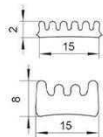

REPDM-E

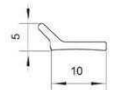

REPDM-L

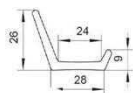

REPDM-L

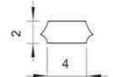

REPDM-I

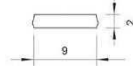
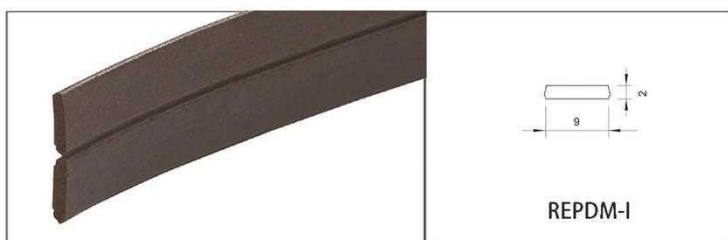

REPDM-I

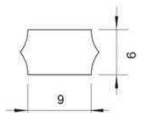

REPDM-I

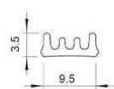

REPDM-W

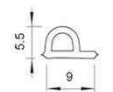

REPDM-P

## RY-EPDM SERIES WEATHER SEALING STRIP

RY-EPDM sealing strip adopts high-temperature shaping microwave vulcanization process, with good tensile and compression deformation resistance, air aging resistance, ozone aging resistance and a wide range of operating temperature (-50C-+150 °C) and other properties, long service life. For different shapes, different materials or different application scenarios characterized by demand, can meet the needs of design and development and use.

- Heat and cold resistance
- Resistant to air and ozone aging
- Wide operating temperature range
- Meets the needs of design development and use



Meets a wide range of design development and utilization needs



Good tensile and compressive deformation resistance

RY-EPDM SERIES WEATHER SEALING STRIP

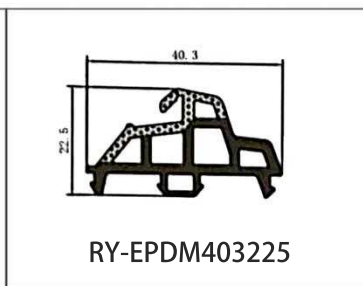
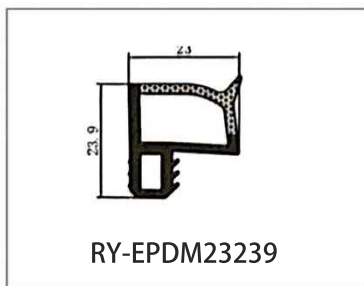
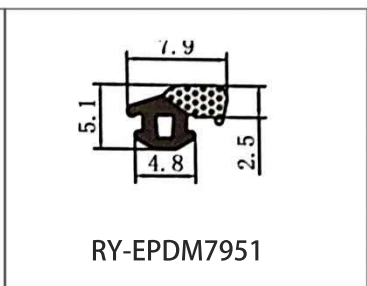
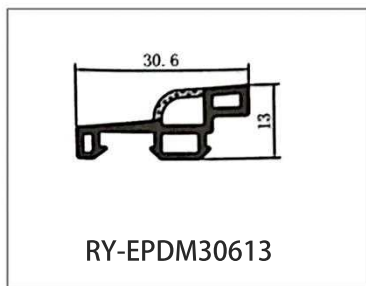
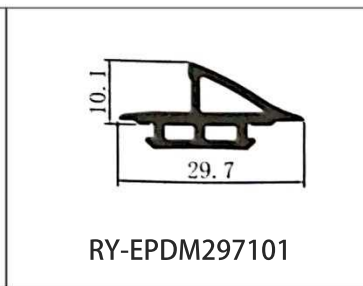
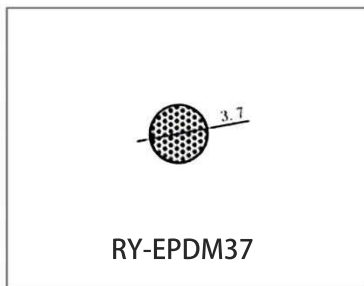
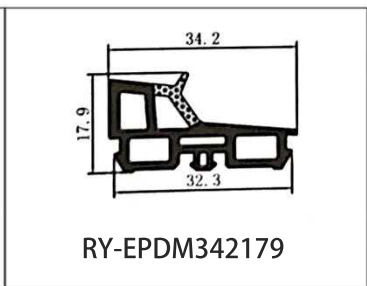
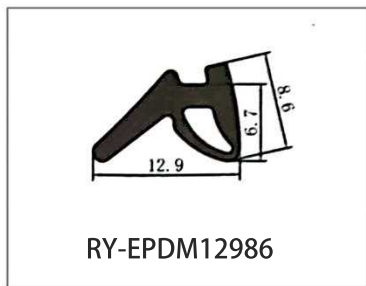
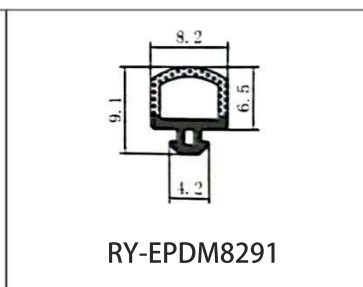
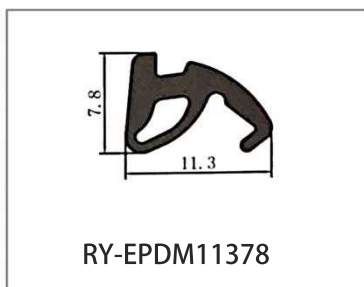
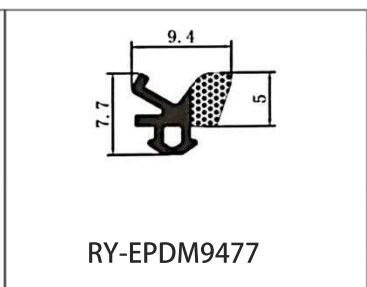
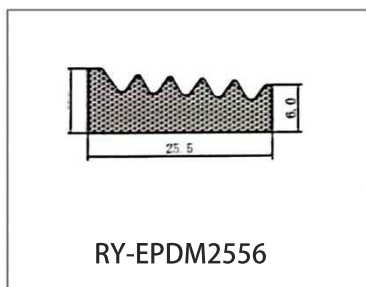
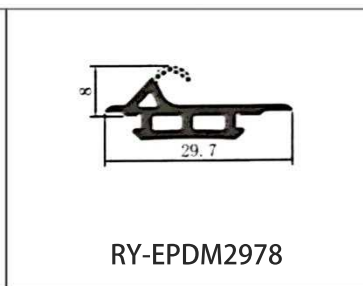
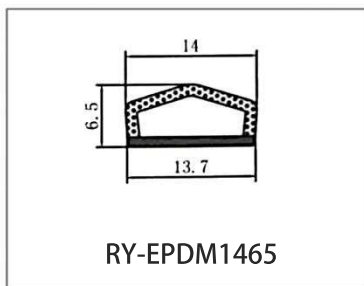
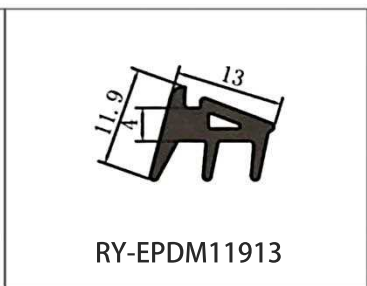
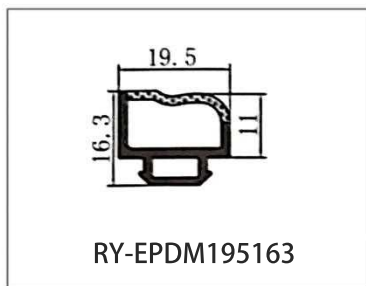
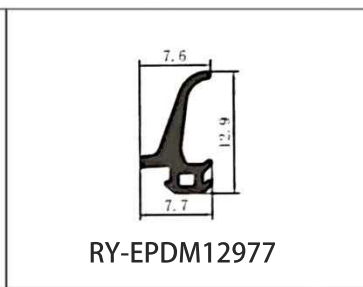
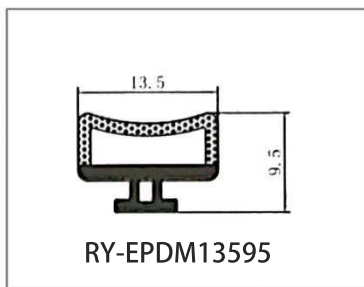
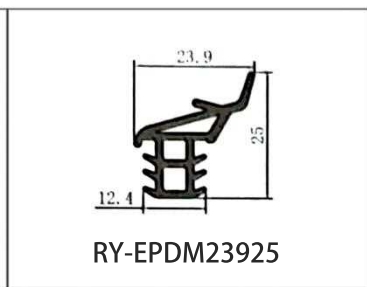
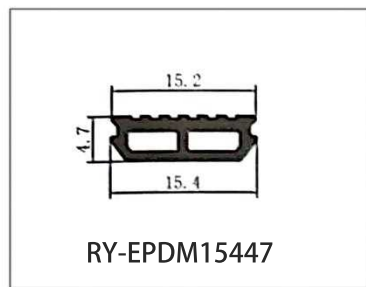
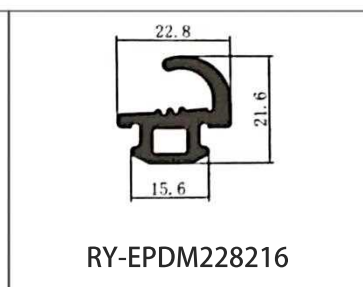
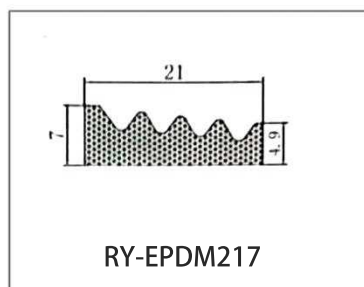
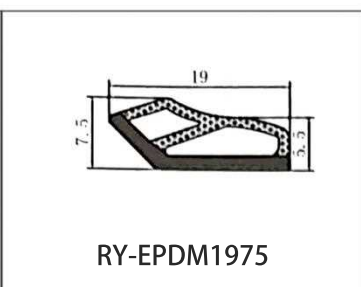
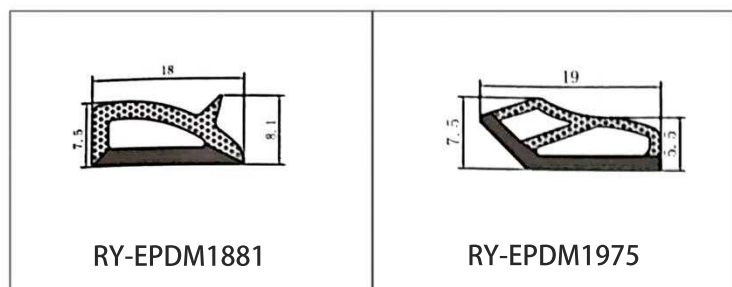

RY-EPDM SERIES WEATHER SEALING STRIP

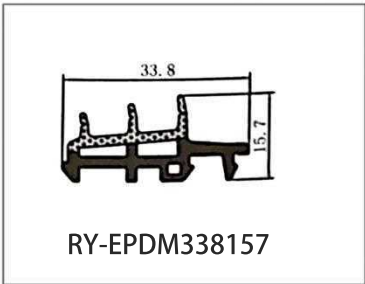
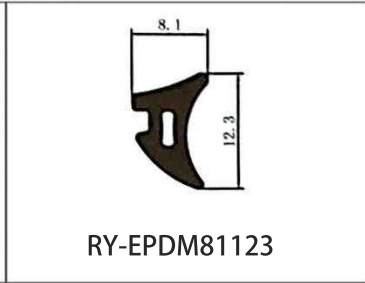
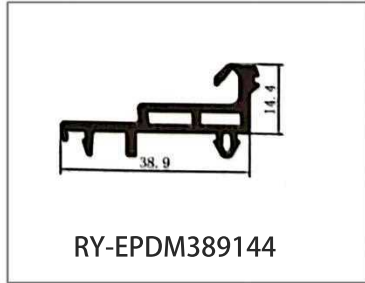
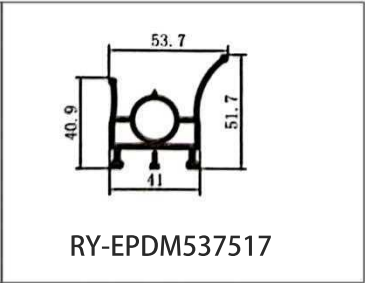
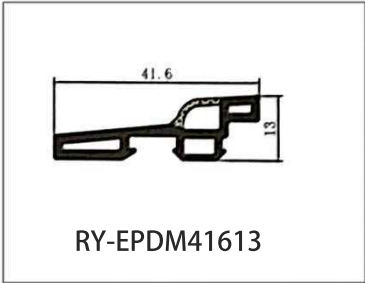
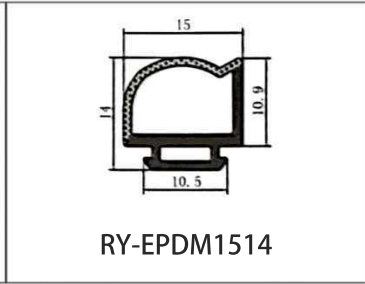
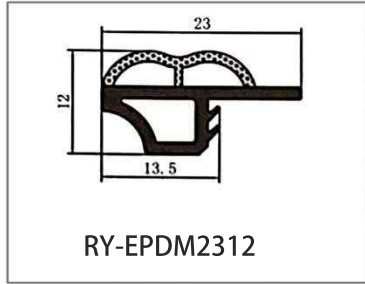
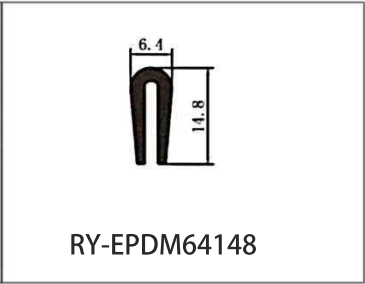
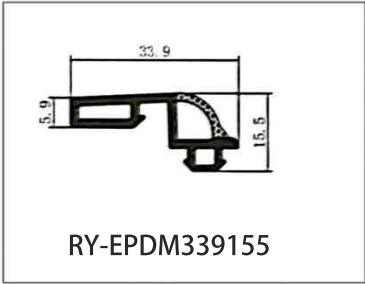
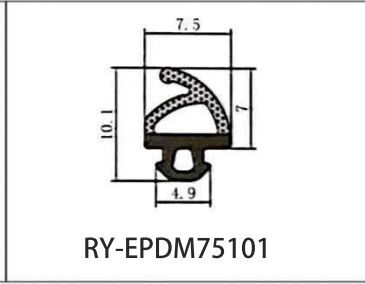
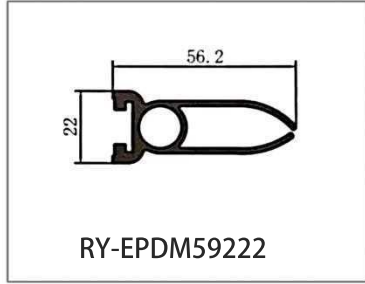
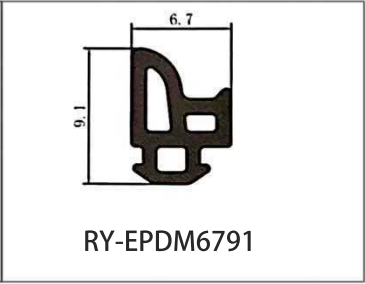
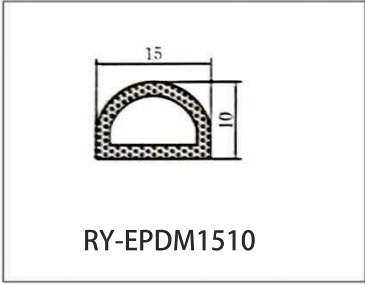
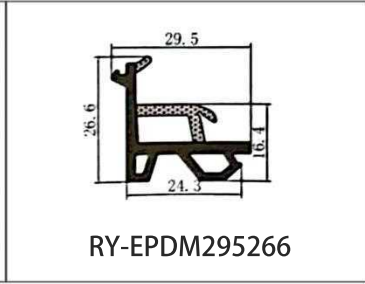
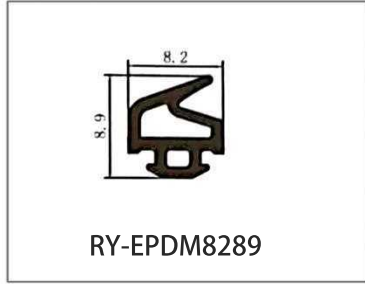
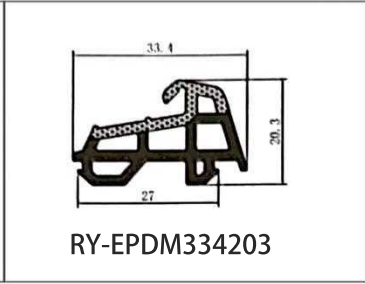
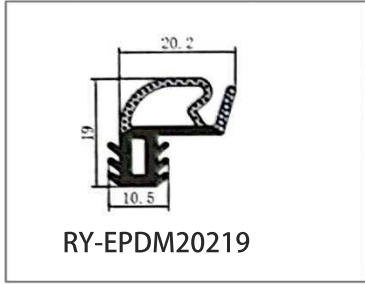
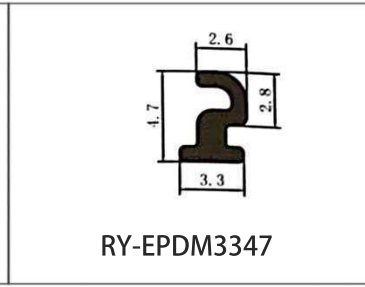
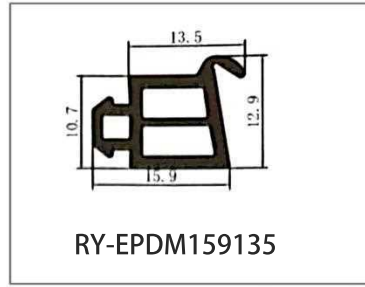
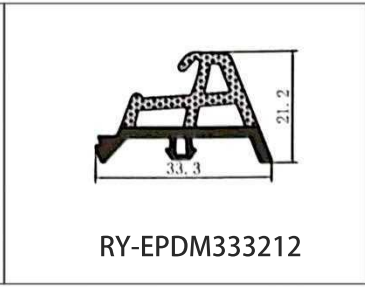
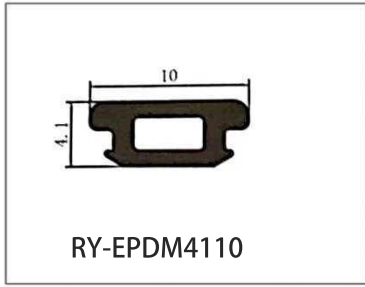

**RY-EPDM SERIES****WEATHER SEALING STRIP FOR ALUMINUM-CLAD WOOD DOOR AND WINDOW**

RY-EPDM series aluminum alloy coated wooden door and window waterproof seal strip can realize seamless corner joining process and better sealing effect. The combination of dense and foam technology, reasonable design will maximize the effect of heat preservation and sound insulation. Excellent aging-resistant materials, adaptable to a variety of working environments. A variety of production processes, can provide the best design program in a timely manner.

Working temperature in -40°C-150°C

Service life can reach more than 25 years

Thermal and acoustic insulation to the extreme

Clip line production to prevent transition stretching

Seamless corner joining process for better sealing effect

Resistant to aging and adaptable to a variety of working environments

Colors can produce colored raw materials, avoiding a single black product



Excellent workmanship, thermal and acoustic insulation to the extreme



Seamless corner joining process for better sealing effect



**RY-EPDM SERIES  
WEATHER SEALING STRIP FOR ALUMINUM-CLAD WOOD DOOR AND WINDOW**

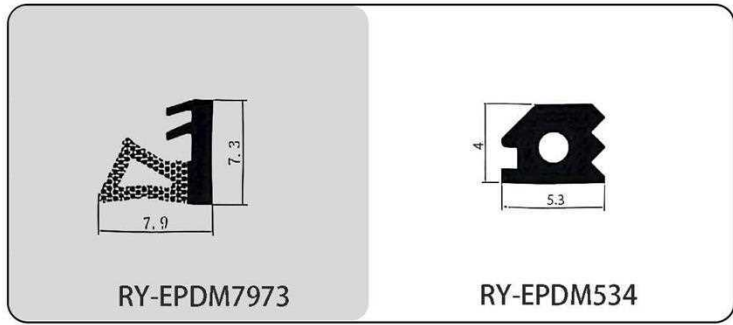
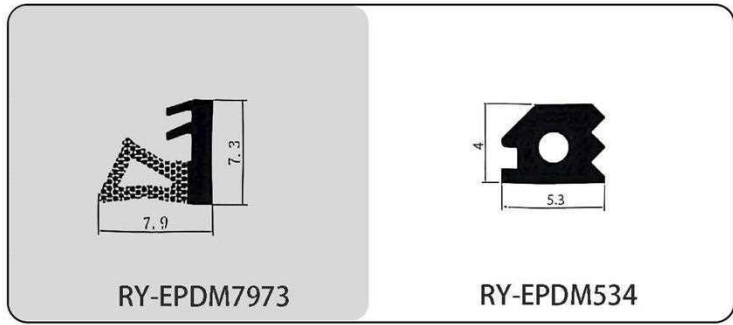
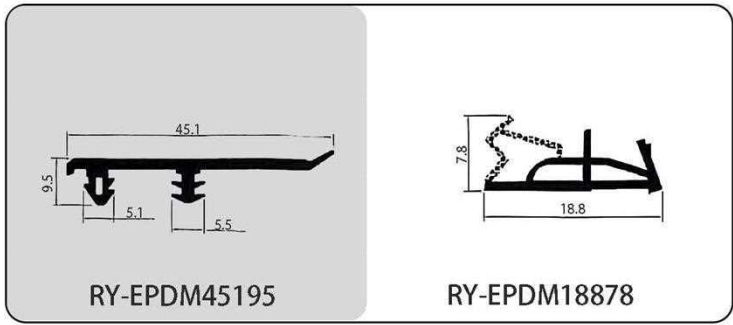
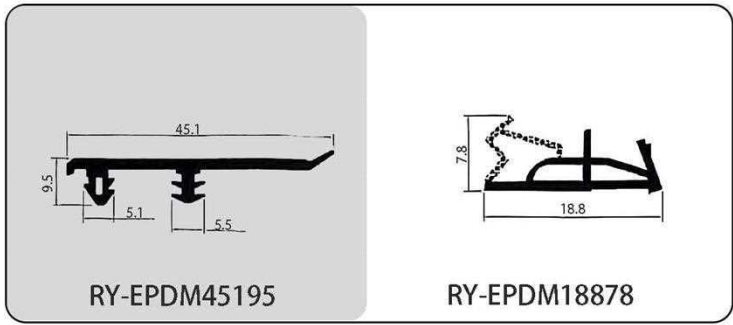
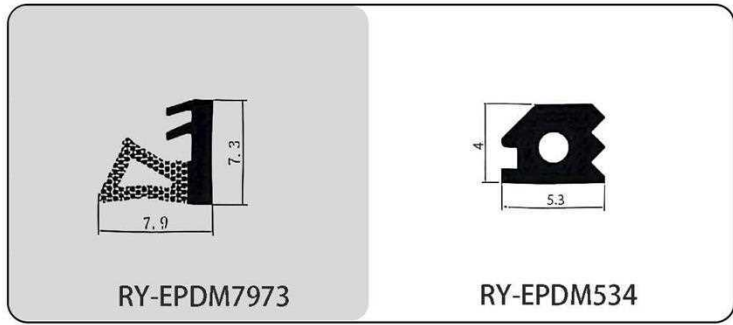
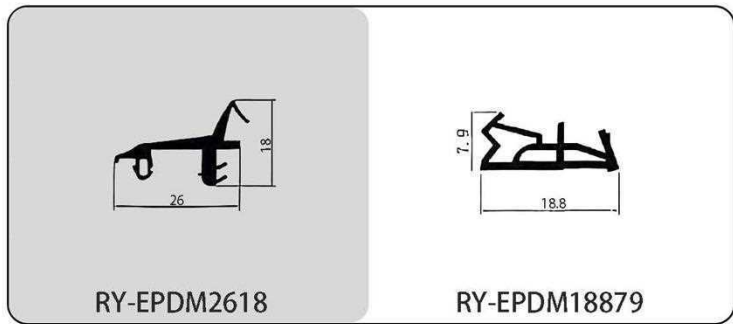
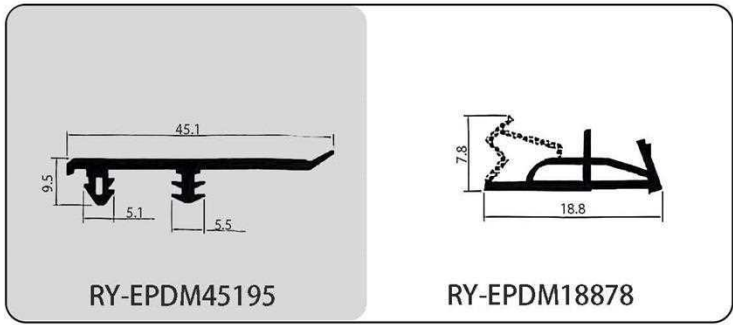
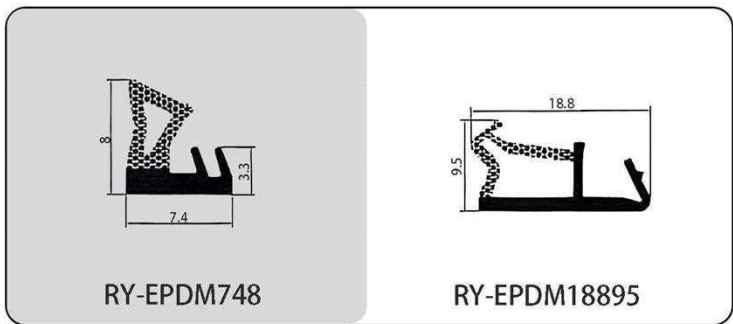
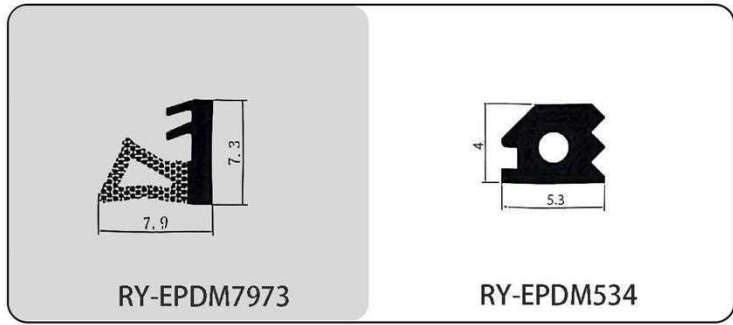
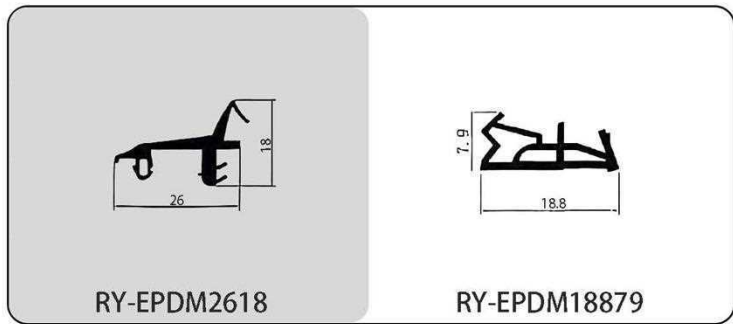
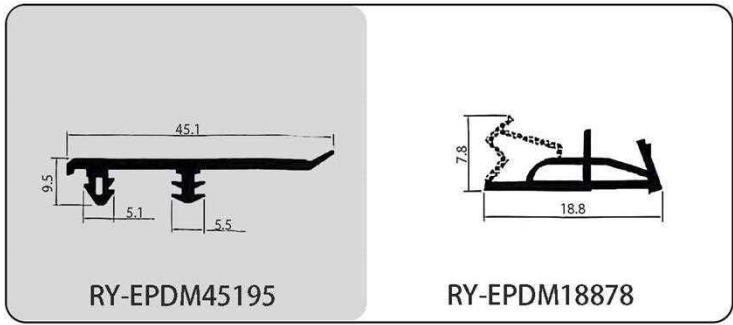
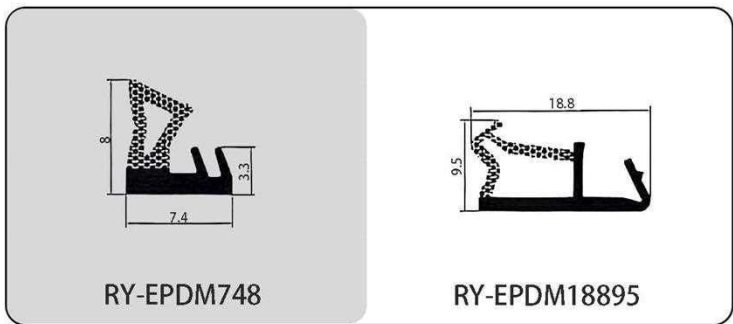
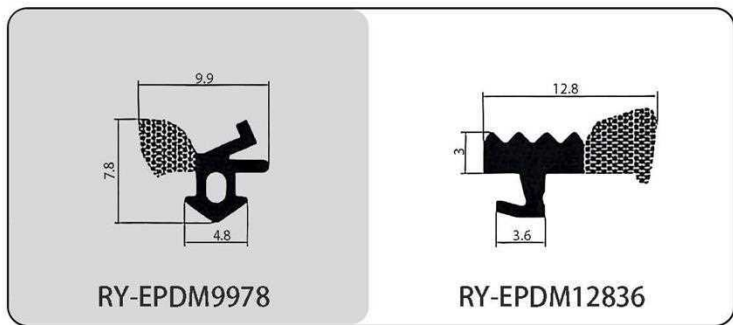
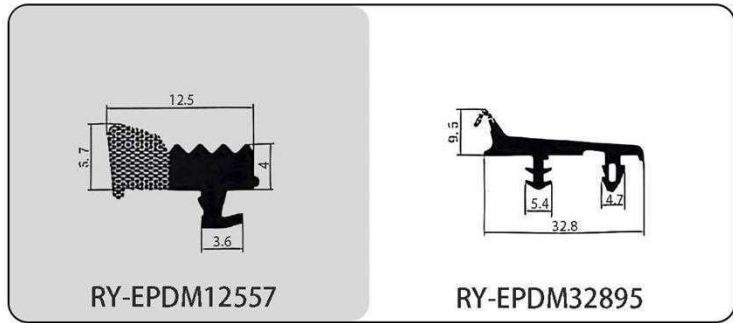
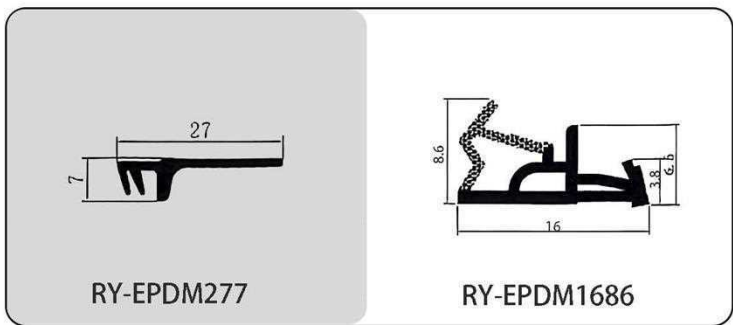
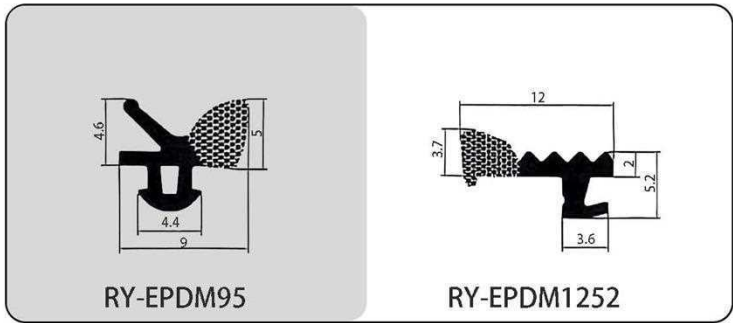

## RY-EPDM SERIES WEATHER SEALING STRIP FOR BRIDGE ALUMINIUM

RY-EPDM series weather sealing strip realize seamless corner joining process, sealing effect is more excellent. The combination of dense and foam technology, reasonable design will achieve the best heat preservation and sound insulation effect. Excellent aging-resistant materials can be adapted to a variety of working environments. A variety of production processes, can provide the best design in a timely manner. Colorful raw materials can be produced to meet a variety of design needs.

Working temperature in  $-40^{\circ}\text{C}$ - $150^{\circ}\text{C}$

Service life can reach more than 25 years

Thermal and acoustic insulation to the extreme

Clip line production to prevent transition stretching

Seamless corner joining process for better sealing effect

Resistant to aging and adaptable to a variety of working environments



Multiple production processes provide optimal design solutions

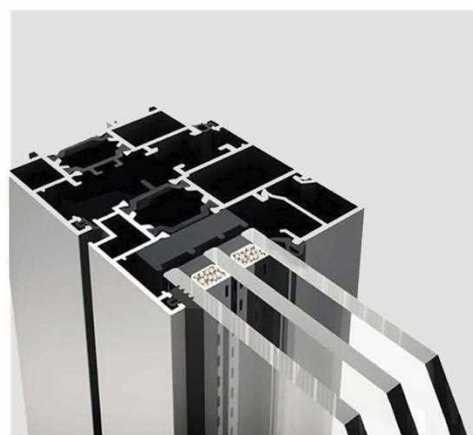

Seamless corner joining process for better sealing effect

**RY-EPDM SERIES WEATHER SEALING STRIP FOR BRIDGE ALUMINIUM**

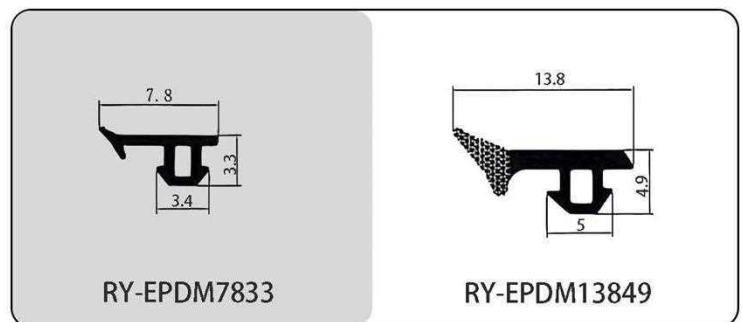
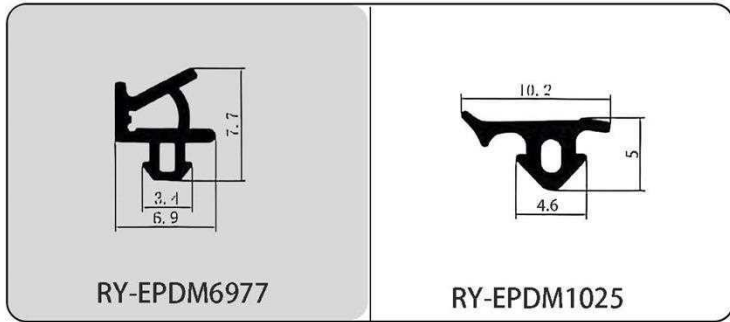
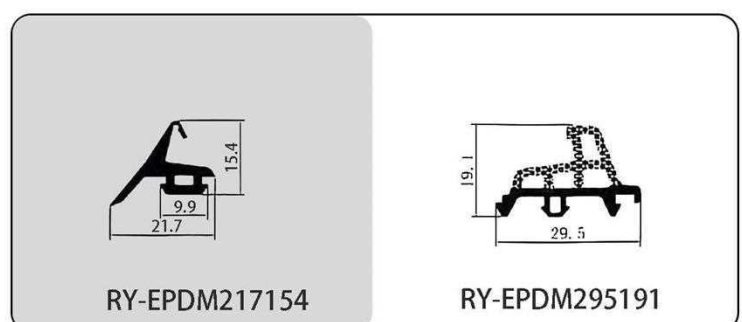
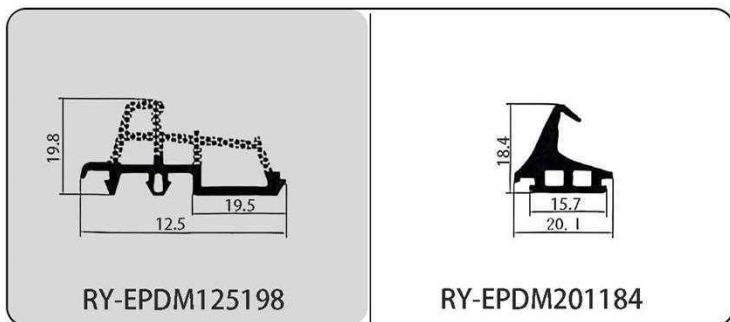
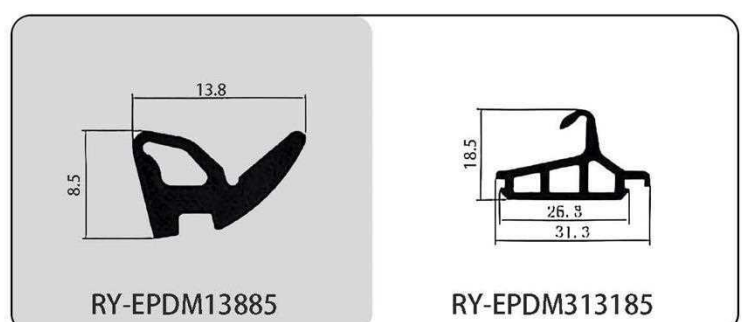
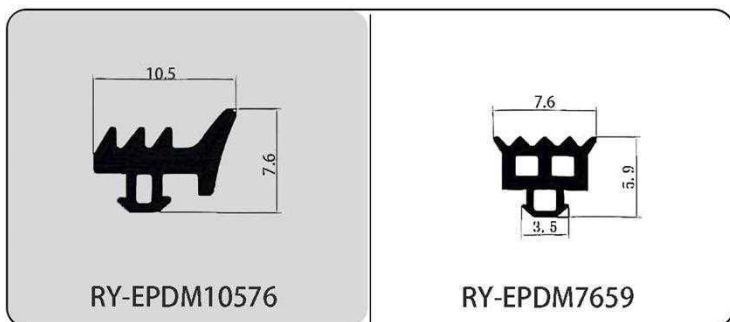
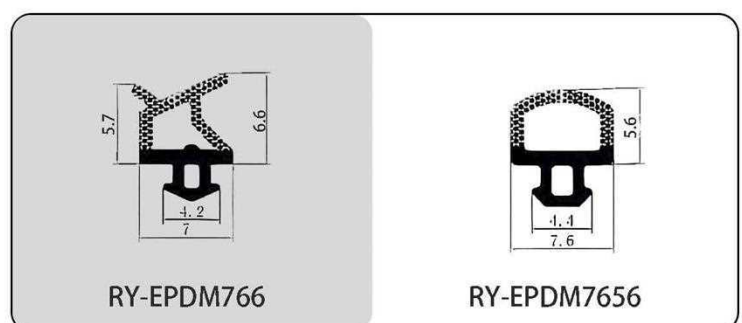
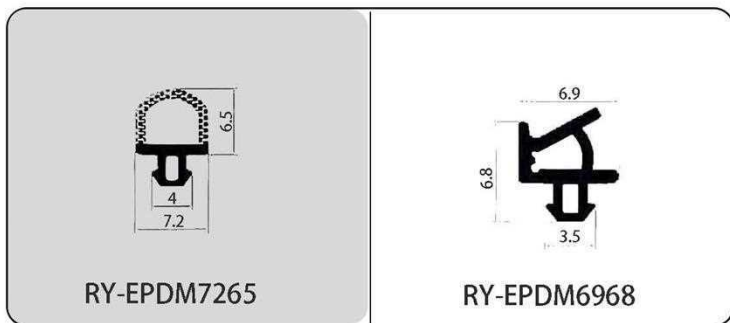
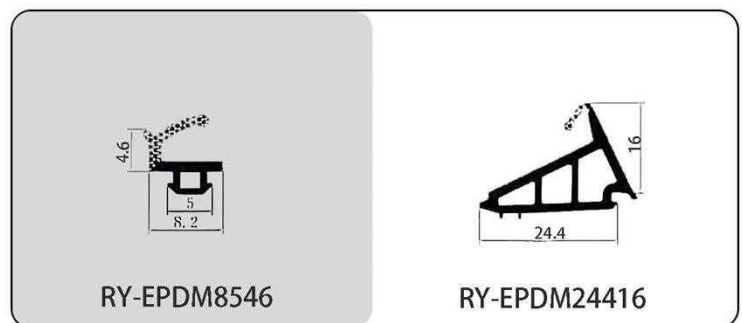
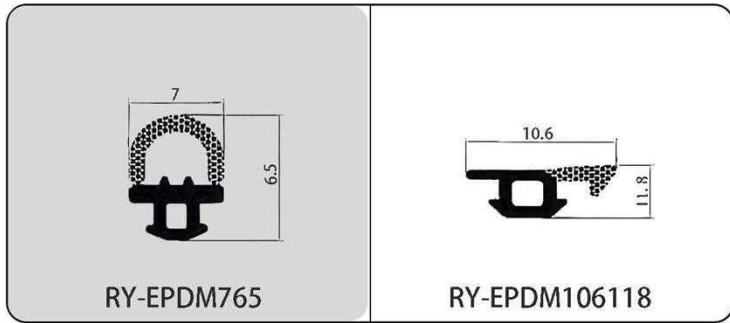

**RY-EPDM SERIES WEATHER SEALING STRIP FOR BRIDGE ALUMINIUM**

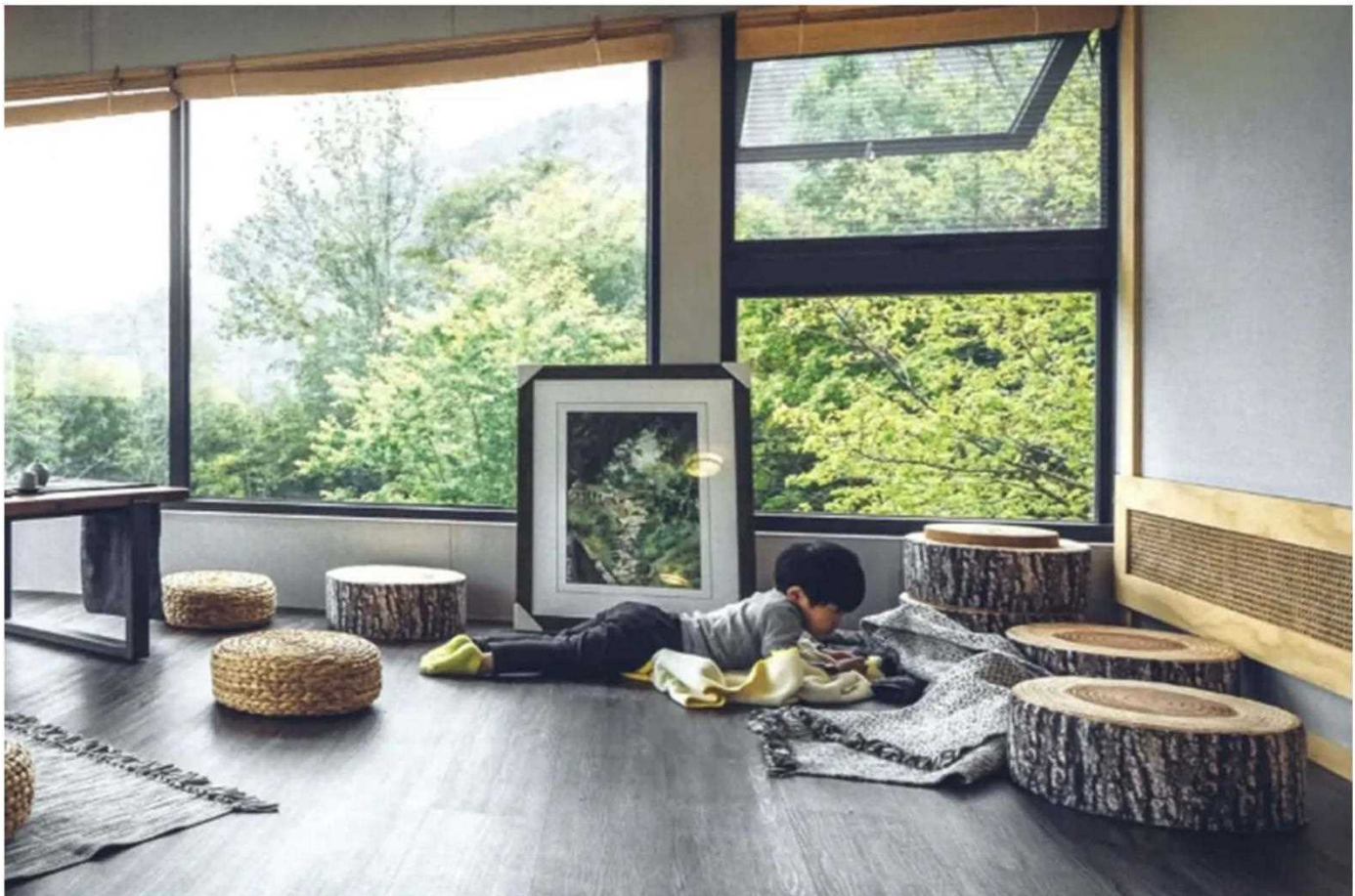
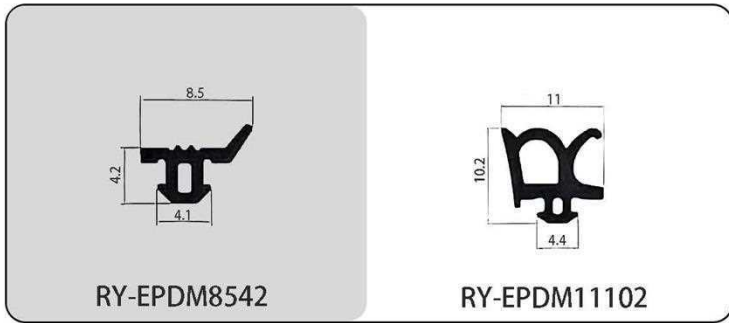

## RYC-EPDM SERIES CORNER JOINT

REPDM-C weldable sealing strips, mainly used in building window and door facade systems, combines the advantages of EPDM material and efficient processing into one, no hardening of adhesive corners in welding, strong thermal insulation, outstanding long-lasting sealing and excellent acoustic and thermal insulation properties, long service life, high elasticity and long-term elastic recovery.

Clean and hygienic indoor climate  
Physical and chemical properties of exposure  
Creating quiet and energy efficient living spaces at home  
Soft and completely sealed corners  
High tolerance compensation for multiple glazing



No gum angle hardening during welding



One-piece adhesive tape for complete sealing

## RYC-EPDM SERIES CORNER JOINT

Low-energy door frame EPDM sealing tape is made of high-quality imported rubber from abroad, adopting automobile and production technology, the whole frame is vulcanized and welded as a whole, and the corners are perfectly fitted to achieve the ultimate sealing.

Airtightness to class 8  
Watertightness class 6  
Wind and dust resistance  
Sound and heat insulation  
Strong thermal insulation



Meets a wide range of design  
development and utilization needs



Good tensile and compressive  
deformation resistance

**RYC-EPDM SERIES CORNER JOINT**

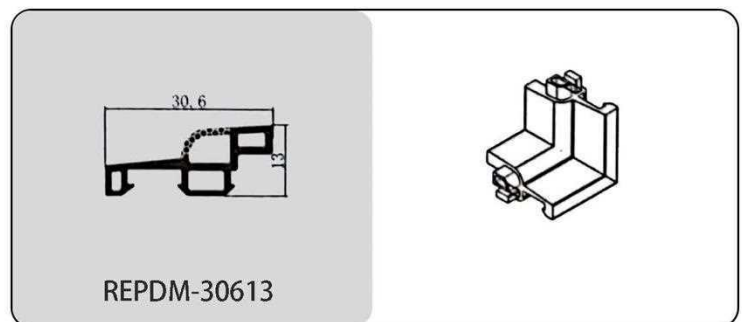
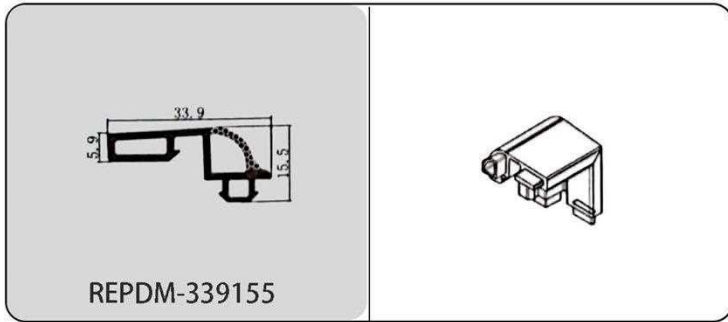
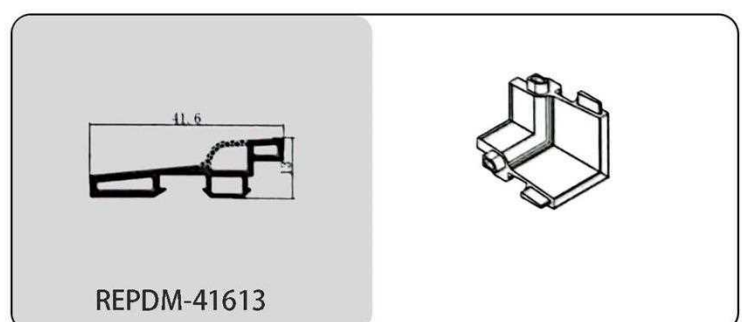
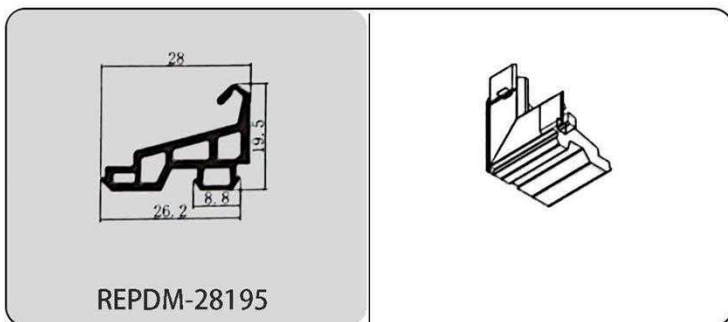
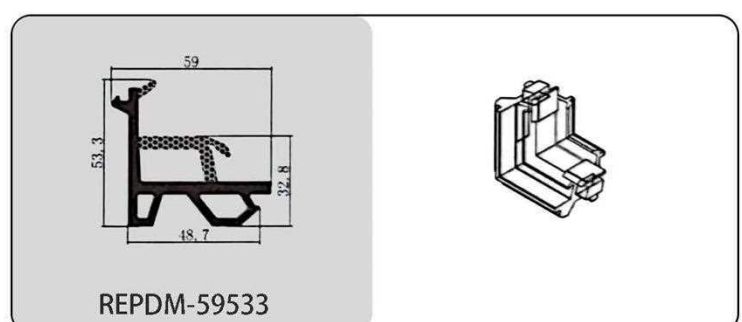
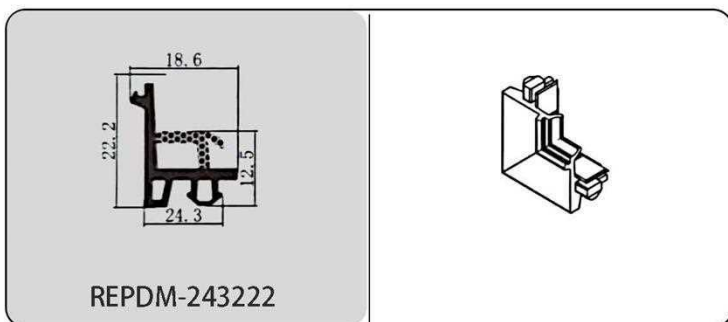
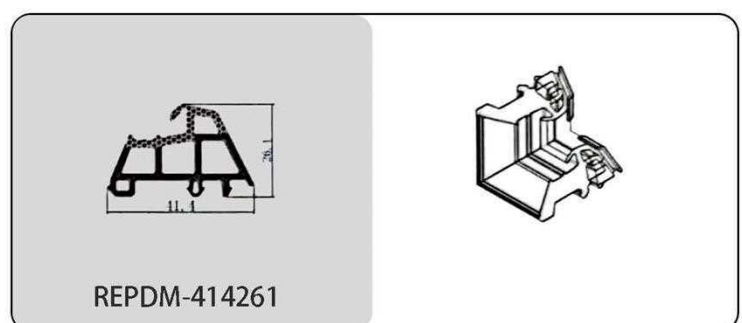
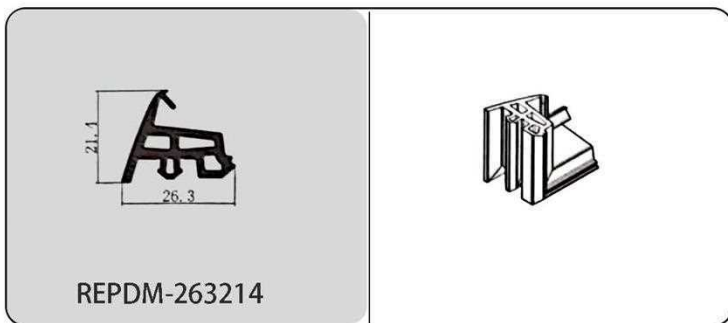
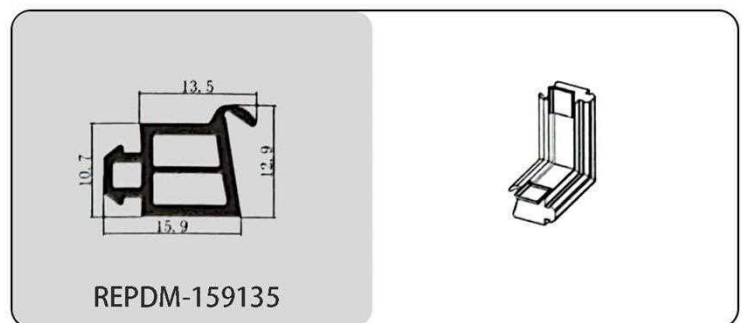
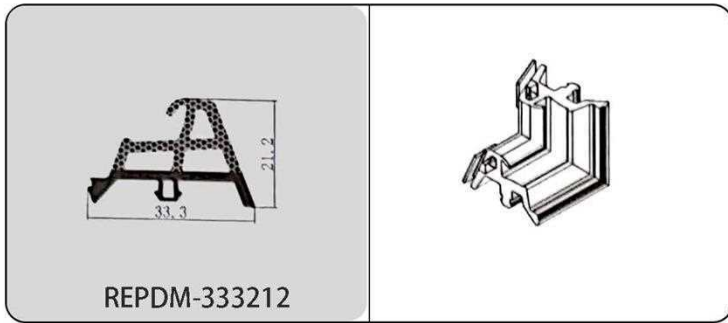

**RYC-EPDM SERIES CORNER JOINT**

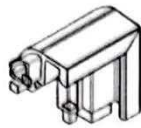
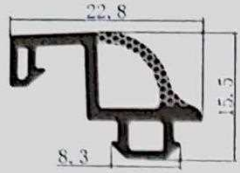

REPDM-228155

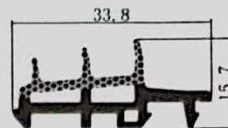

REPDM-338157

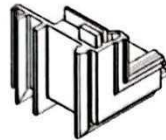

REPDM-389144

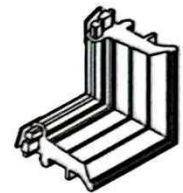
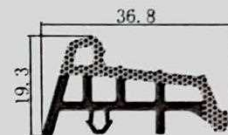

REPDM-368193

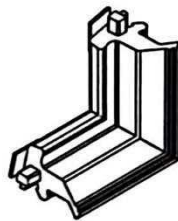
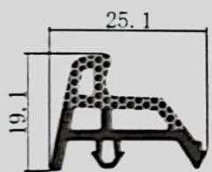

REPDM-251191



REPDM-75101

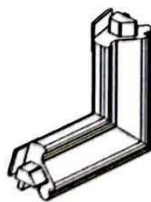
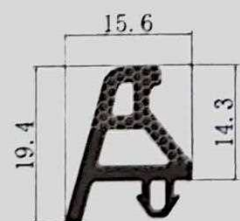

REPDM-156194

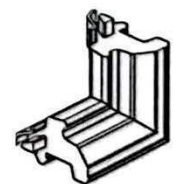
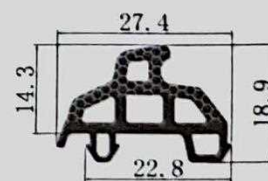

REPDM-274189



## REPDM-CK SERIES GARAGE DOOR BOTTOM SEAL

The garage door bottom seal effectively enhances the garage experience and environmental quality through a variety of functions such as waterproofing, dustproofing, insect-proofing, windproofing, soundproofing, light-proofing and protecting the garage door, and is an important device to keep the garage interior dry, clean, safe and comfortable.

**Anti-crash:** Provides cushioning when closing the door

**Soundproofing:** Reduces noise from outside

**Waterproof:** Effectively prevents rain and ground water from entering the garage through the doorway.

**Simple installation:** simple design, easy to install

**High-quality EPDM material** is wear-resistant and aging-resistant

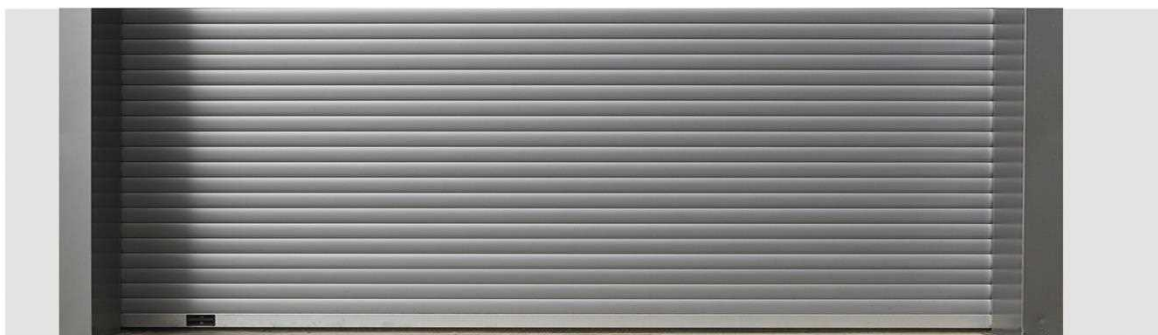

### REPDM-CK01

Composed of EPDM material, easy to install on the bottom of the garage door for waterproof soundproofing, vibration damping and sealing.



### REPDM-CK02

Made of EPDM material, it can be easily installed on the bottom and sides of the garage door for vibration dampening, pest control, soundproofing and sealing. Can be used in combination with REPDM-CK01

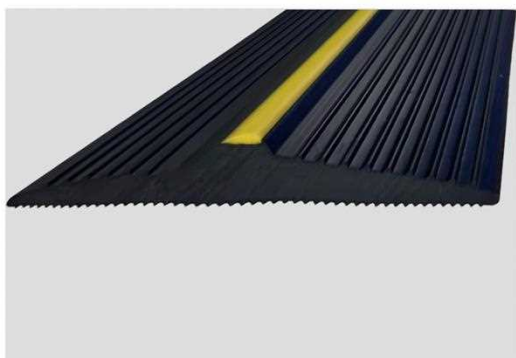

### REPDM-CK03

Made of PVC material, it can be easily installed at the bottom of the garage door for vibration damping, windproof waterproof, insect-proof and sealing.

**RBFW SERIES  
PE COVERED PU FOAMING ACOUSTIC SEALING STRIP FOR DOORS AND WINDOWS**

Material: PU foaming covered by PE

Beautiful surface

Resistance to UV

Resistance to ozone erosion

Resistance to water and oil

Weather and aging resistance

Wide temperature range -40 to 90

Stable performance and long service life



Colors are optional

**Air Flow Test**

**Air flowing**

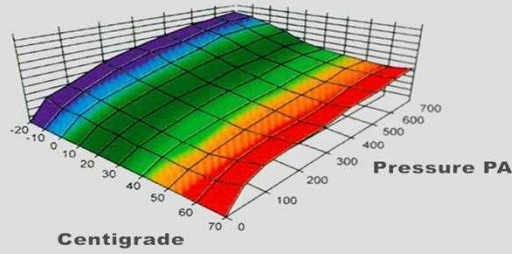

**Air flowing**

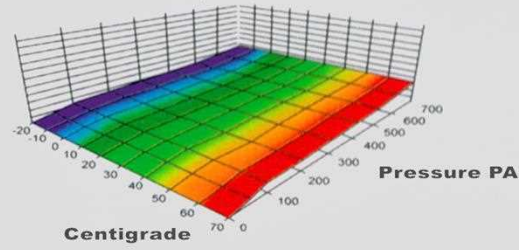

**Installation Diagram**



**RBFW SERIES  
PE COVERED PU FOAMING ACOUSTIC SEALING STRIP FOR DOORS AND WINDOWS**

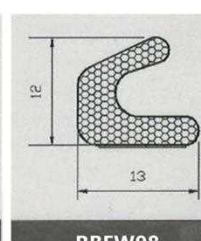
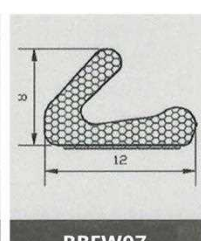
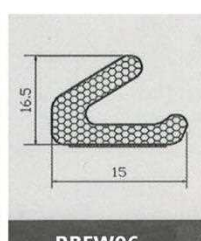
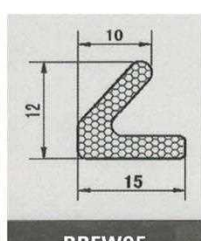
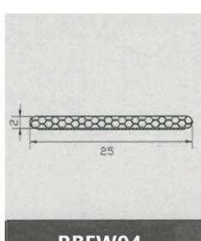
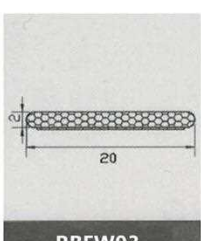
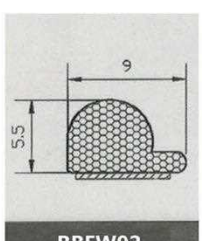
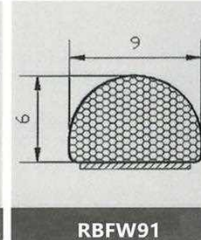
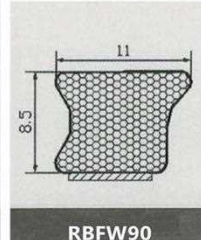
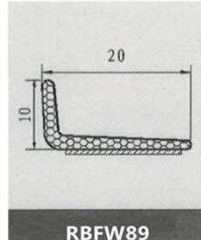
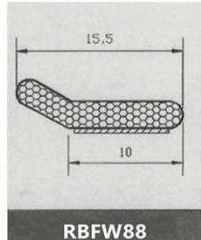
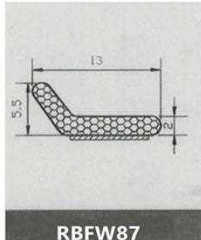
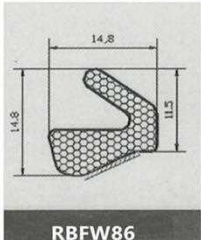
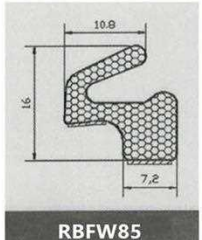
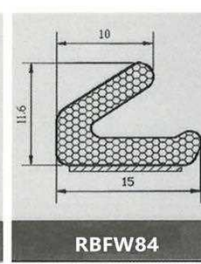
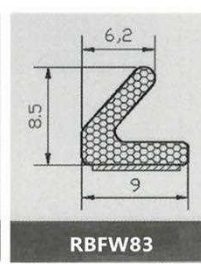
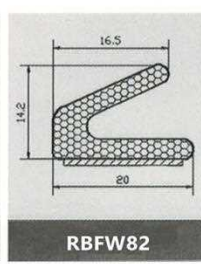
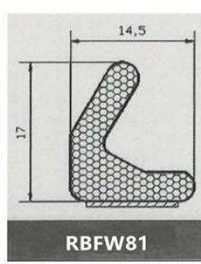
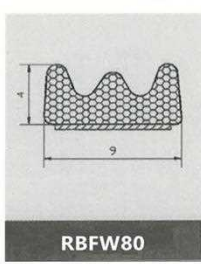
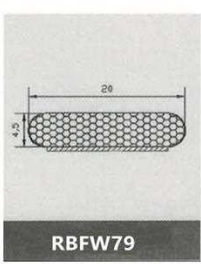
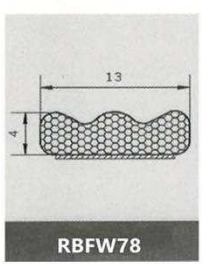
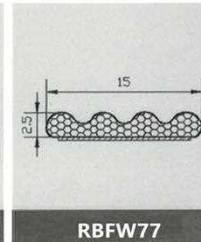
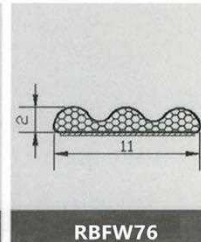
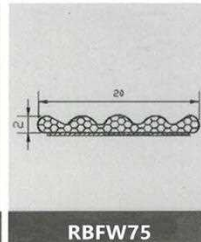
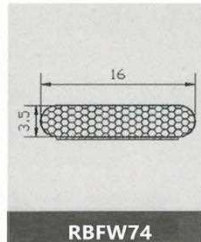
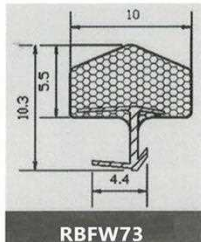
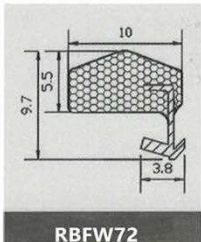
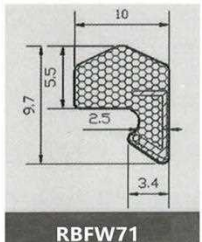
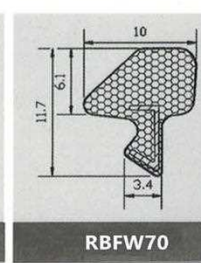
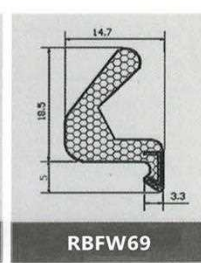
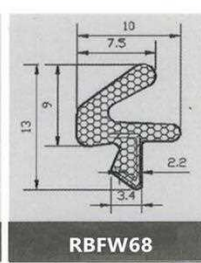
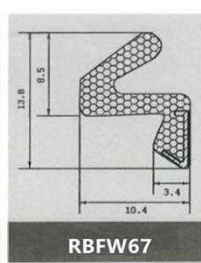
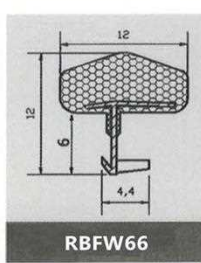
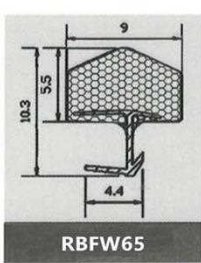
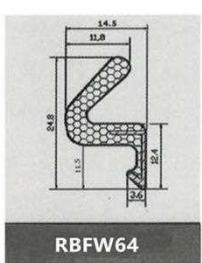
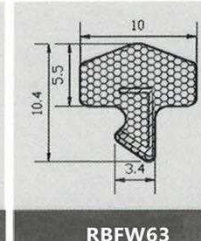
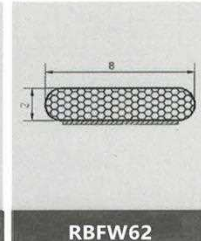
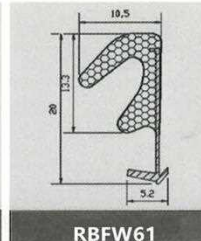
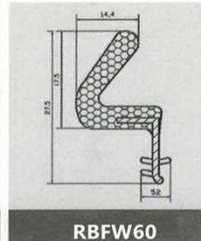
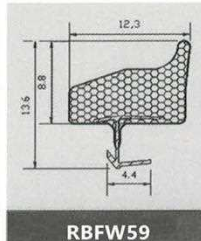
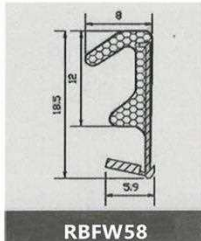
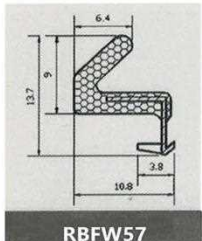
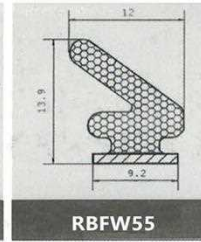
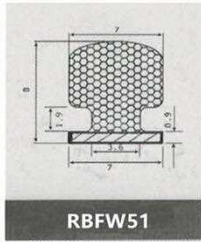

**RBFW SERIES**  
**PE COVERED PU FOAMING ACOUSTIC SEALING STRIP FOR DOORS AND WINDOWS**

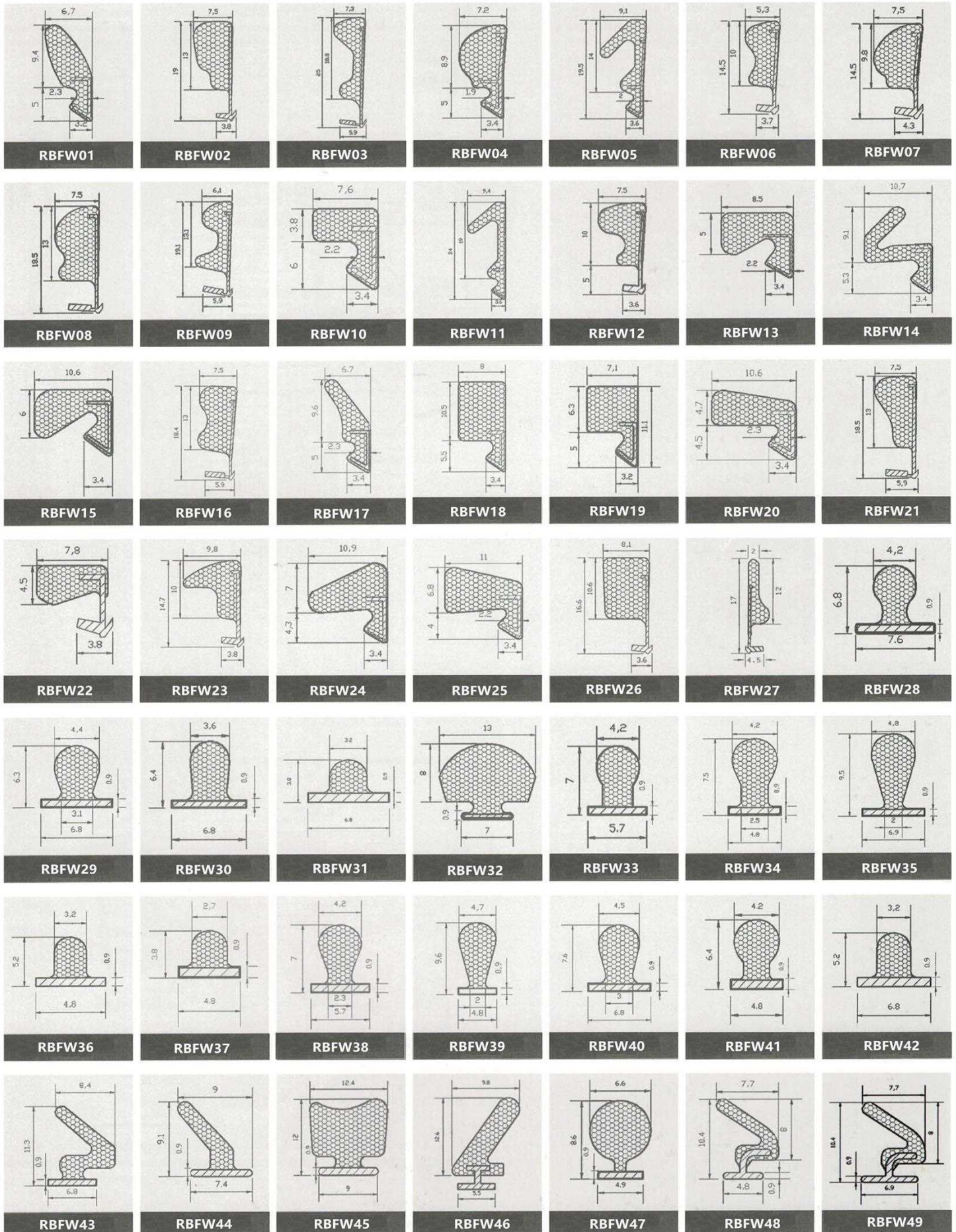

**RBFW SERIES  
PE COVERED PU FOAMING ACOUSTIC SEALING STRIP FOR DOORS AND WINDOWS**

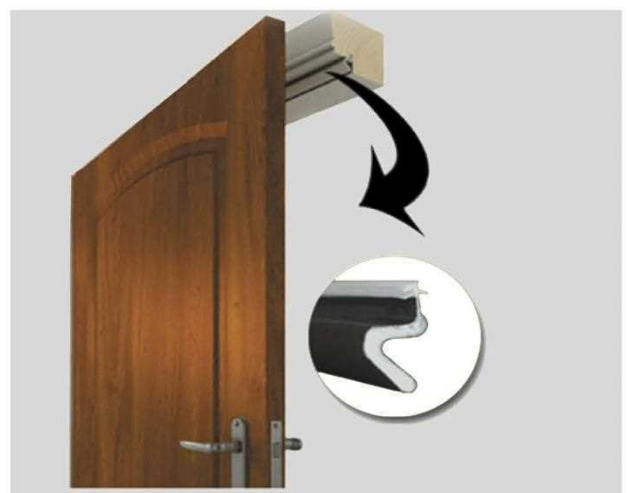
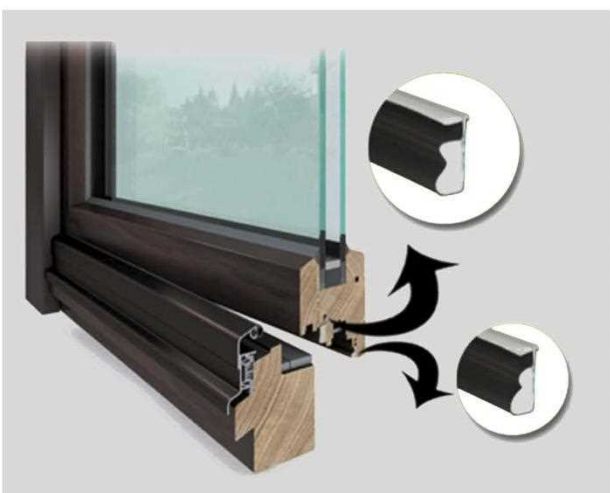
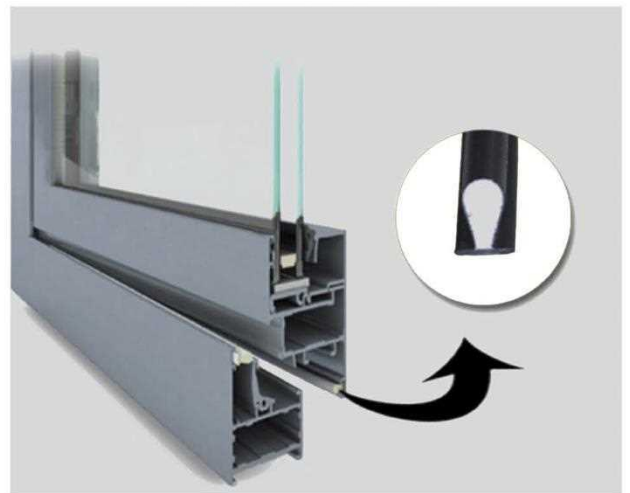
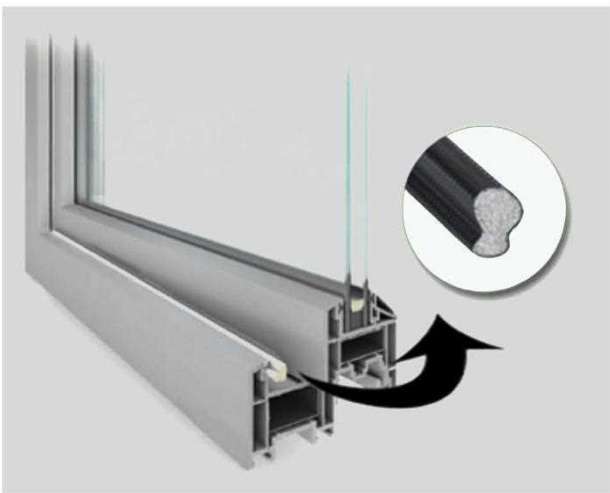
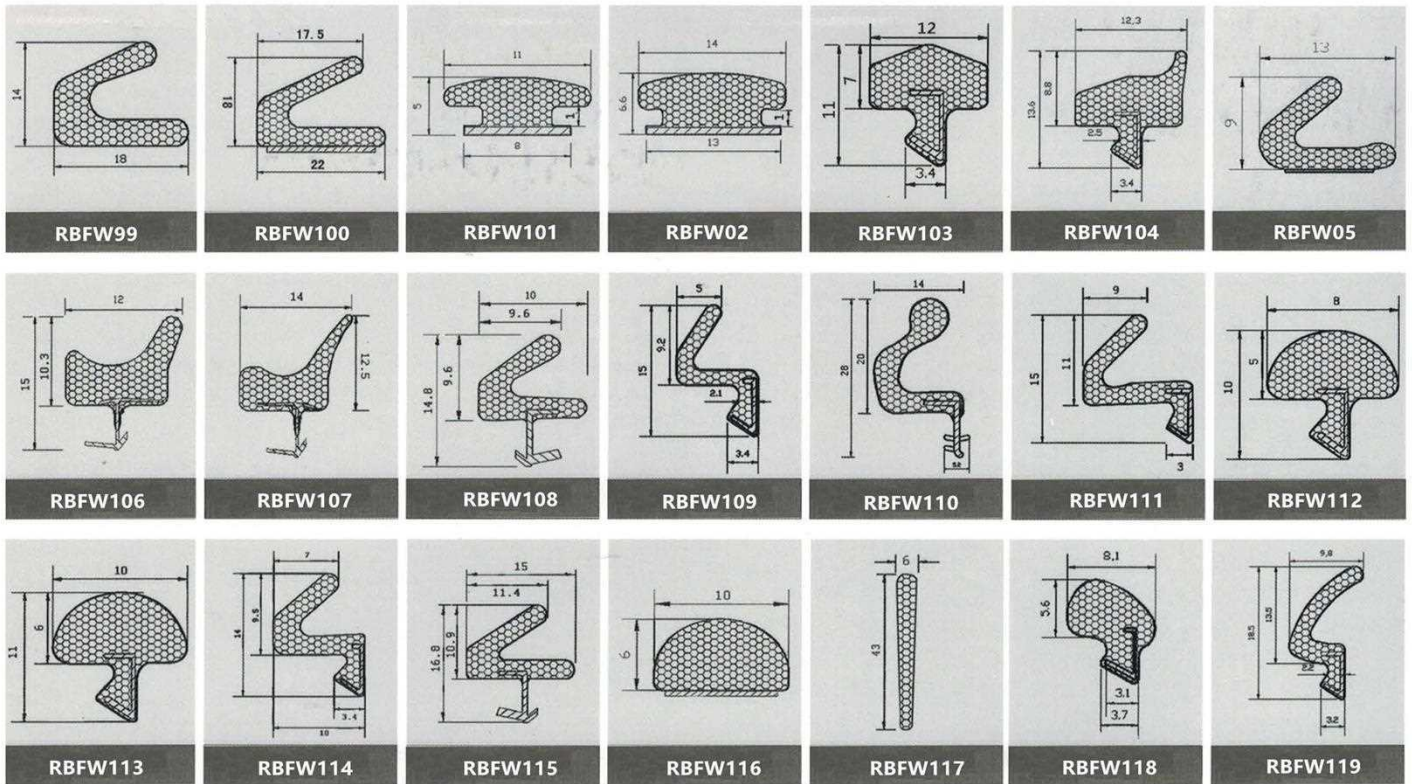

## RBFW SERIES PU FOAMED ACOUSTIC SEAL

RBF series weather stripping, using the international leading sealing concept and advanced production technology, made through the composite application of a variety of polymer materials, can adapt to a variety of extreme weather, and on the basis of the original products increased fire expansion series, and access to the national mandatory product certification, able to meet more needs.

- Good weathering and UV resistance
- Excellent resilience
- Greater compression
- Wider range of sizes available
- Better tensile and anti-shrinkage properties



Color is optional brown white black grey



Adoption of international leading sealing concept and advanced production technology



Made of a variety of polymer materials composite application

## RBFW SERIES PU FOAMED ACOUSTIC SEAL

Wrap-around PU high soundproof sealing series, using the international leading sealing concept and advanced production technology, through a variety of polymer materials composite application made to adapt to a variety of extreme weather, and increase the fire expansion series, the difference between EPDM and PVC sealing strips, the product airtightness is stronger, sound insulation is more outstanding.

Sound insulation class V in combination with application scenarios

National fire protection certification has been obtained

Compression permanent deformation less than 5%

Resistant to high and low temperatures from -60°C to +70°C

No sticking, no hardening, no color fading

Strong fatigue resistance

More advantages in watertightness and airtightness



RBFW is more advantageous in terms of watertightness and airtightness



Enclosed soundproofing performance is even more

**RTXT SERIES  
INSERT TYPE ACOUSTIC SEALING STRIP FOR WOODEN DOOR AND WINDOW**

RTXT made of the high quality flexible modify PVC/TPE material, it is a high elastic doorstop frame seal suitable for wooden door groove frame. It has the excellent sound insulation, dust insulation and decorative effect. Because of the good elastic and flexibility characteristic, it has stable shape with long-term use life and can effectively prevent the noise dust wind and rain.

Colors are optional

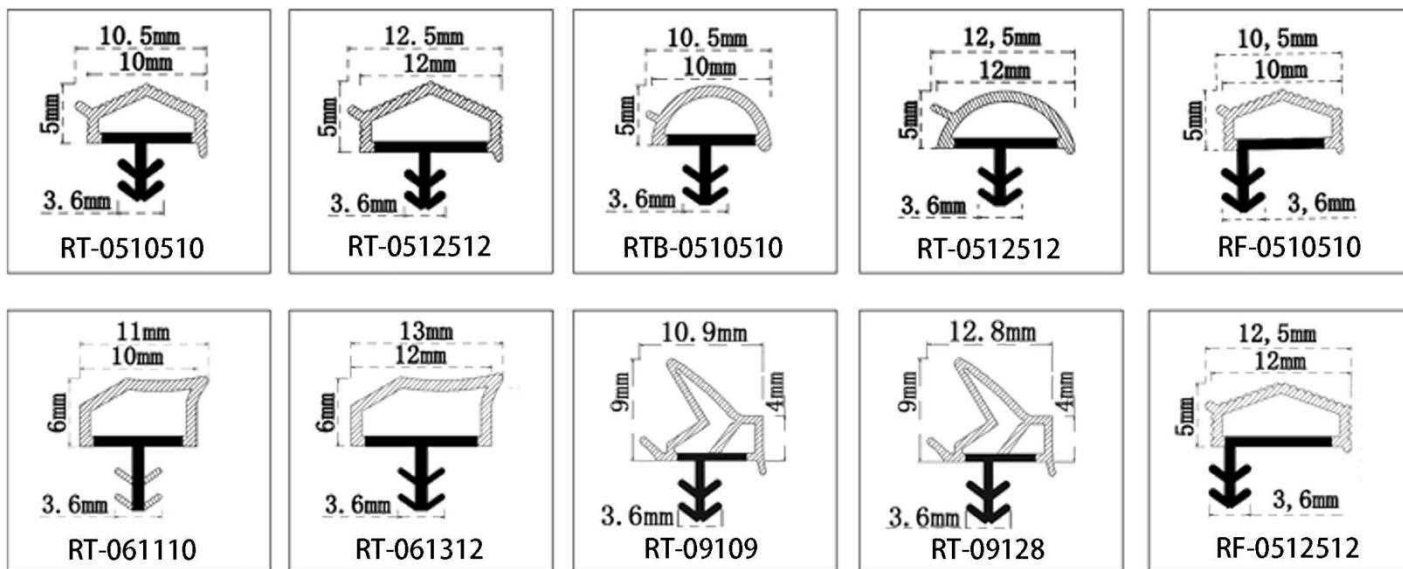
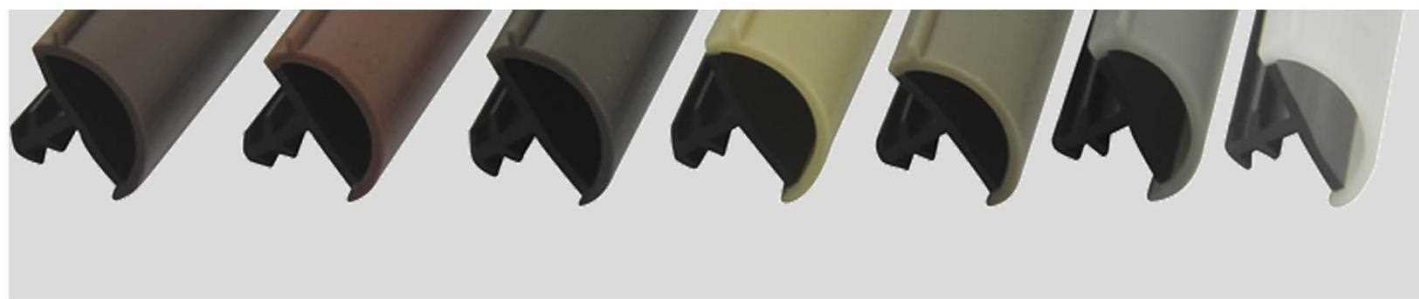
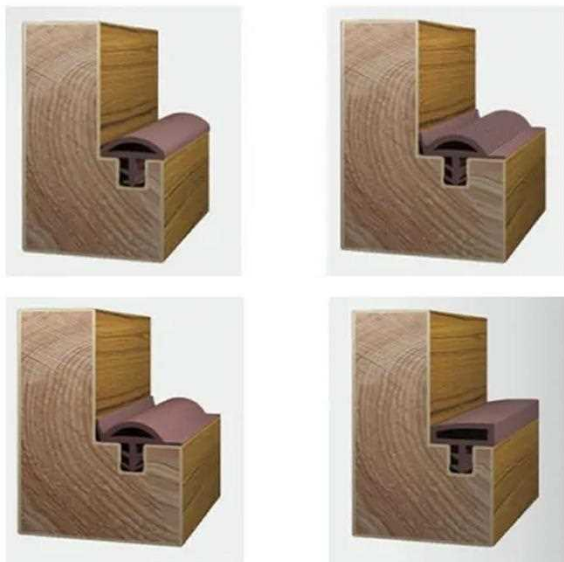



**RTXT SERIES  
INSERT TYPE ACOUSTIC SEALING STRIP FOR WOODEN DOOR AND WINDOW**

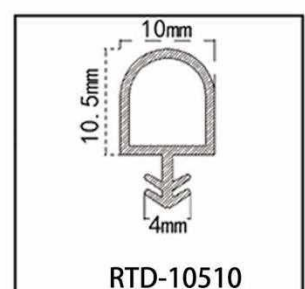
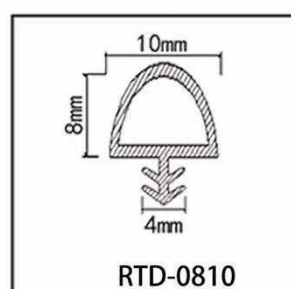
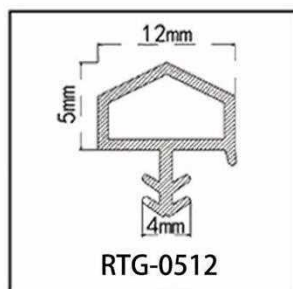
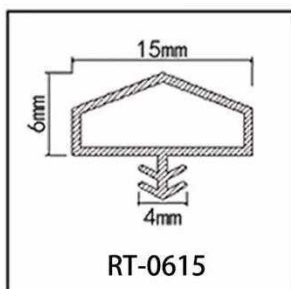
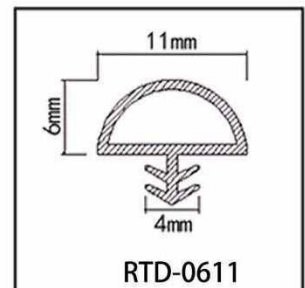
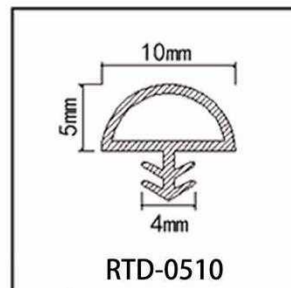
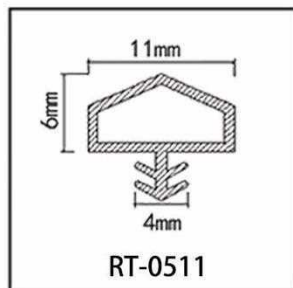
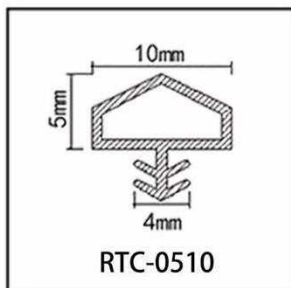
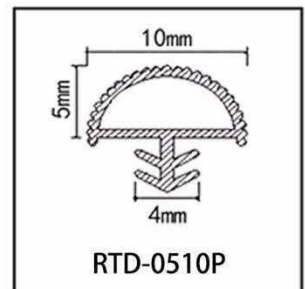
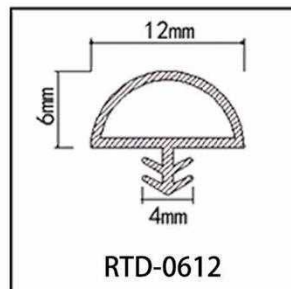
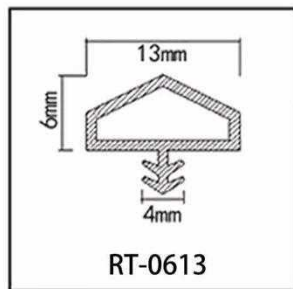
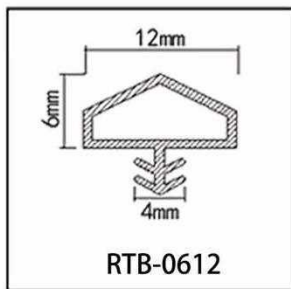
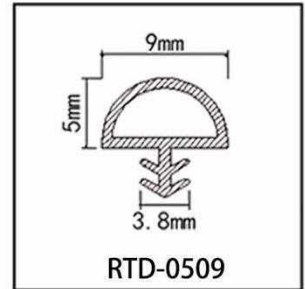
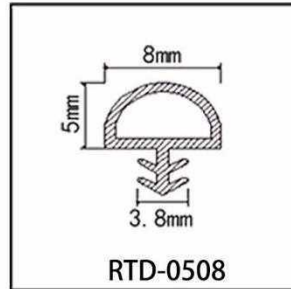
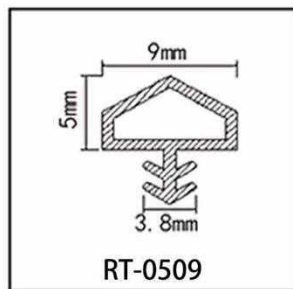
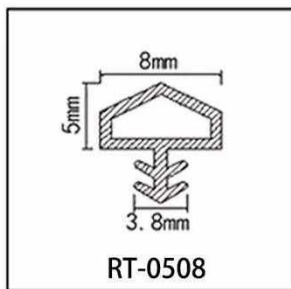

**RTXT SERIES  
INSERT TYPE ACOUSTIC SEALING STRIP FOR WOODEN DOOR AND WINDOW**

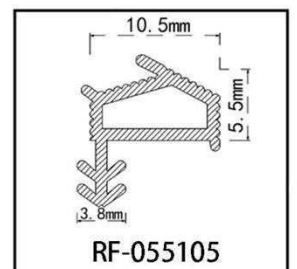
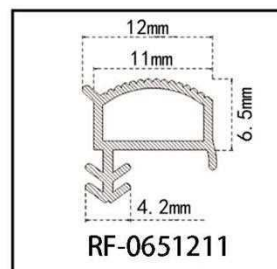
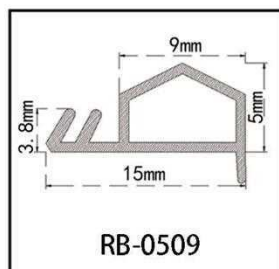
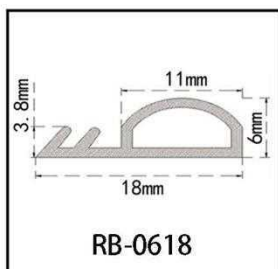
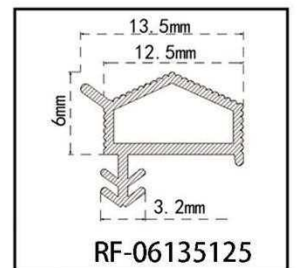
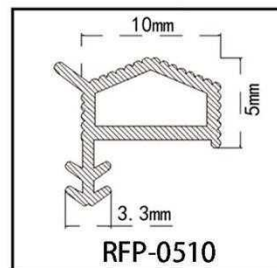
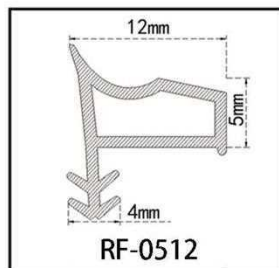
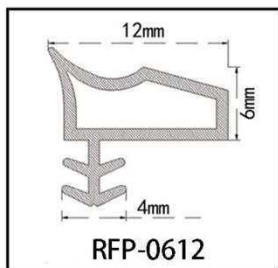
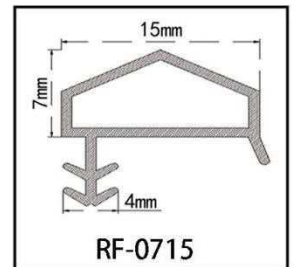
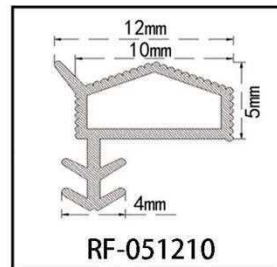
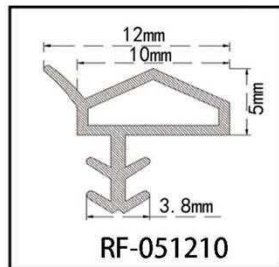
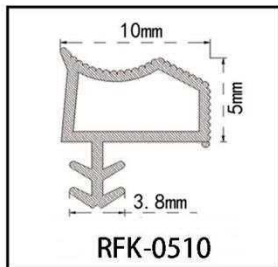
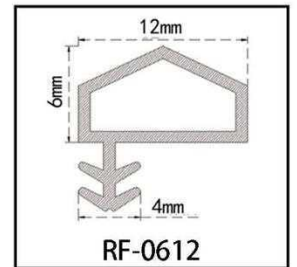
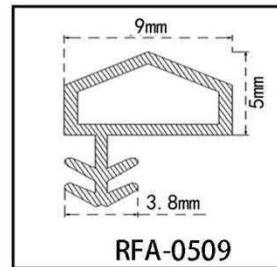
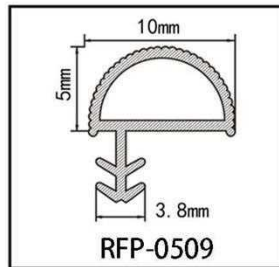
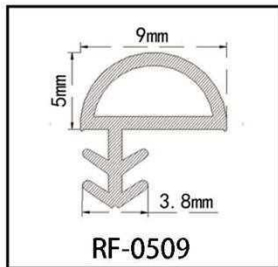
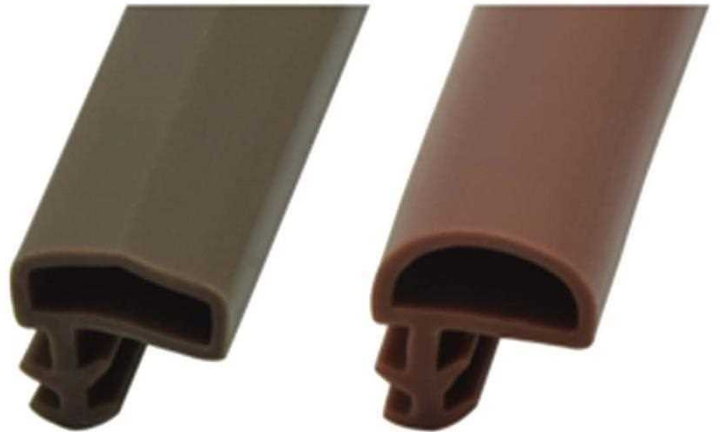

**RTXT SERIES  
INSERT TYPE ACOUSTIC SEALING STRIP FOR WOODEN DOOR AND WINDOW**

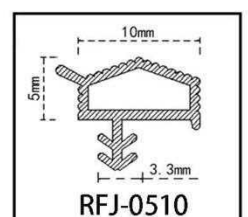
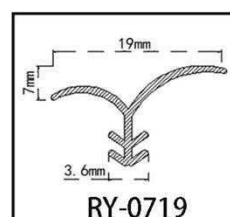
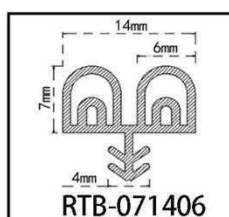
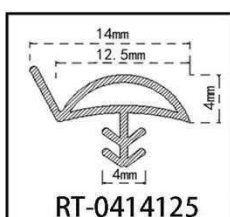
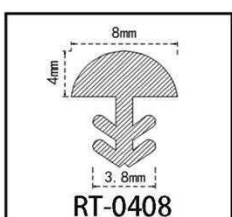
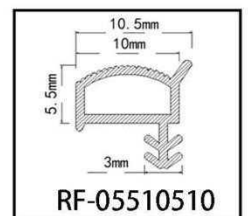
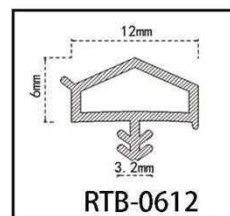
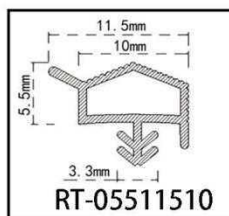
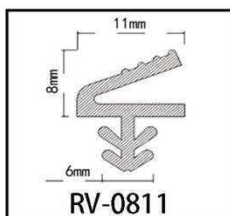
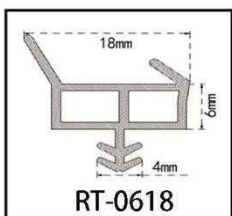
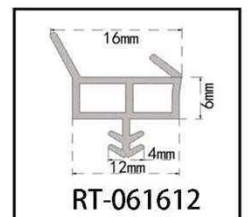
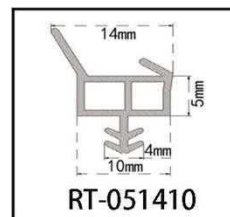
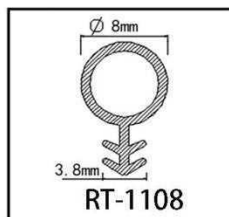
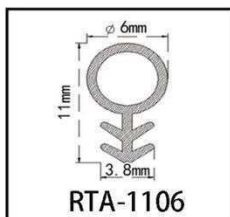
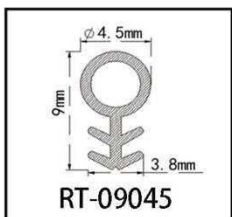
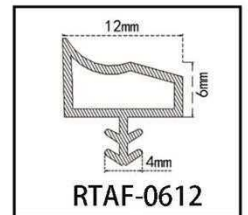
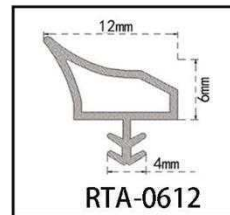
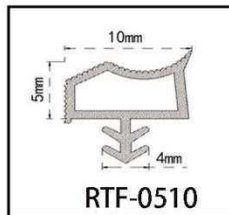
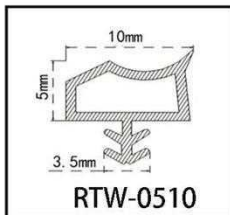
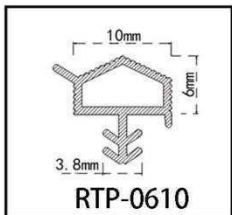
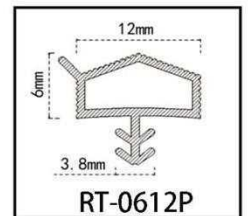
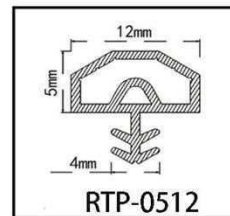
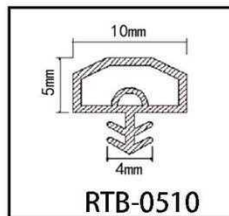
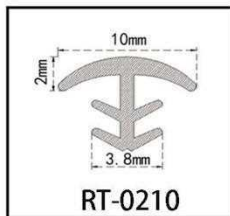
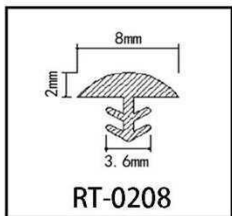

RTXT SERIES  
INSERT TYPE ACOUSTIC SEALING STRIP FOR WOODEN DOOR AND WINDOW

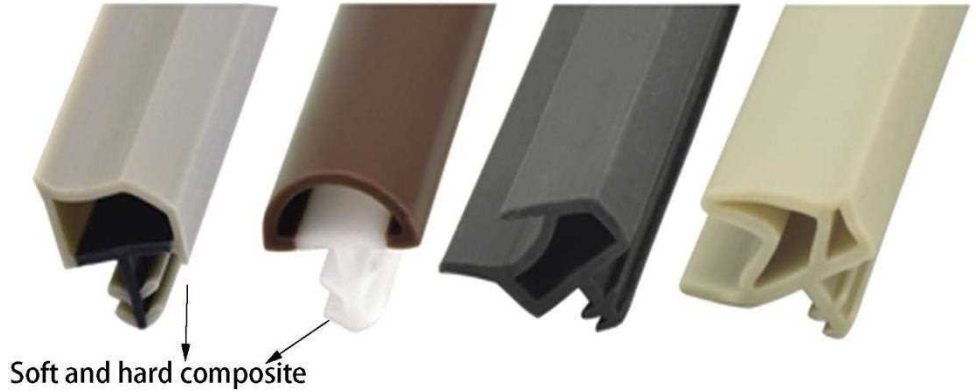

Soft and hard composite

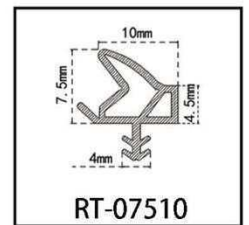
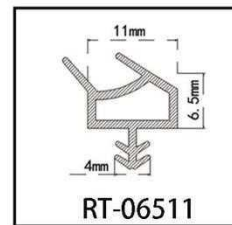
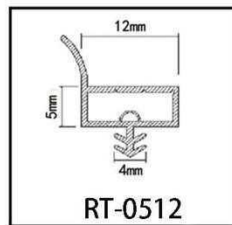
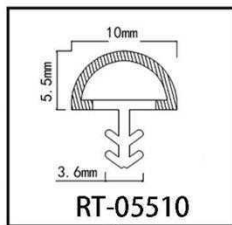
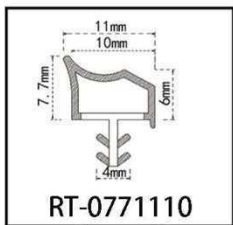

soft and hard composite

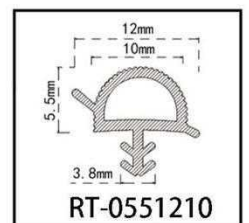
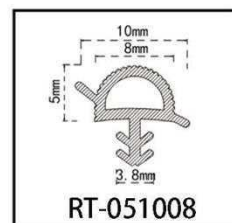
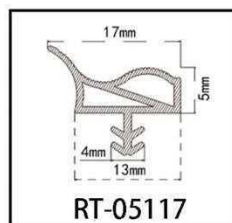
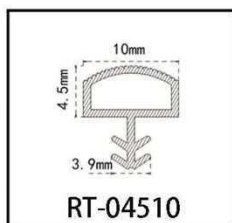
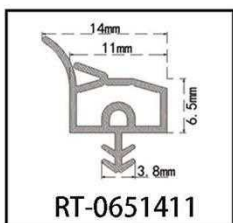
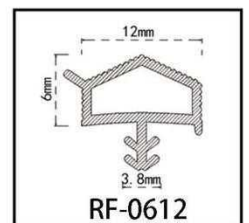
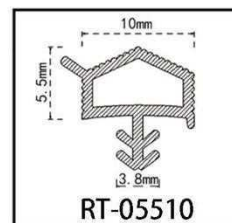
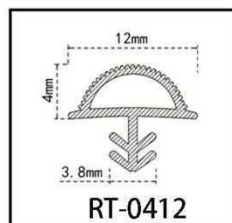
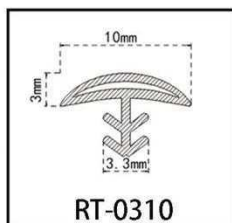
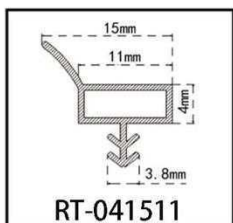
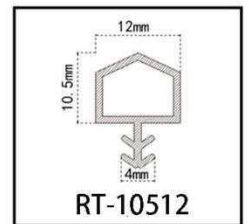
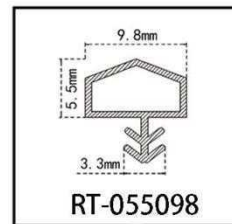
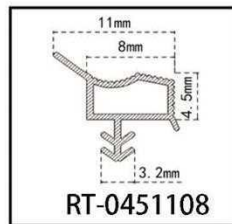
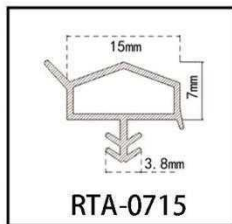
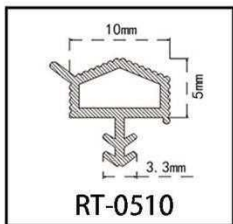
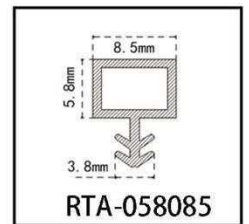
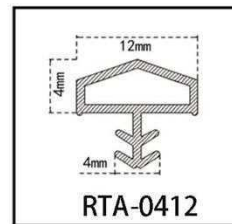
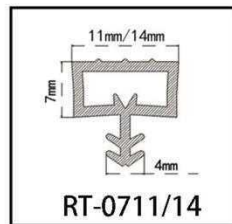
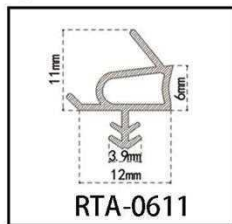
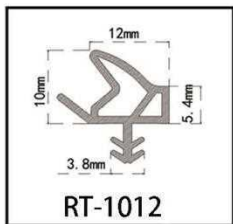

**RRYSJJ SERIES  
ACOUSTIC AND SMOKE CORNER SEAL**

RRYSJJ series acoustic and smoke corner seal provides the acoustic smoke and heat (cold & hot) sealing for the gaps of door edges and frames.

Unique easy installation

Product comes with strong self-adhesive

Minimum gap seal size 3mm/4mm

Excellent compression and deflection performance

Reduced door closing force due to a low co-efficient material of fins

Regular color is brown

Color customization is available

**RRYSJJ Series Acoustic and Smoke Corner Seal**

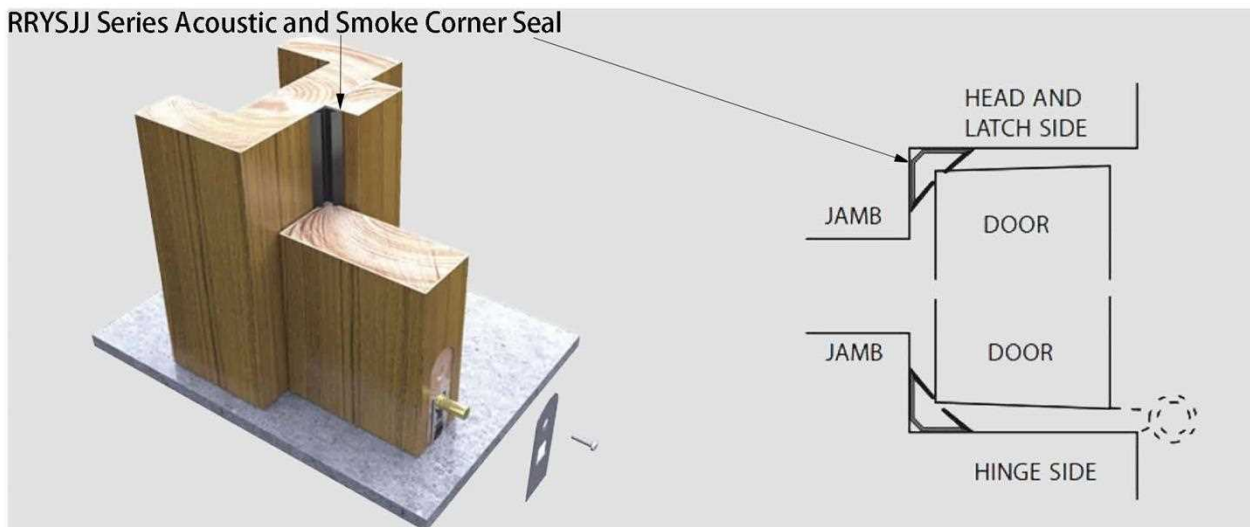

Rigid part is typically used to maintain shape and provide structural support, while soft part is utilized for sealing and flexibility, ensuring better adaptation to various surfaces and shapes.

This combination effectively prevents smoke from infiltrating indoors through door or window gaps, while ensuring durability and reliability in installation.

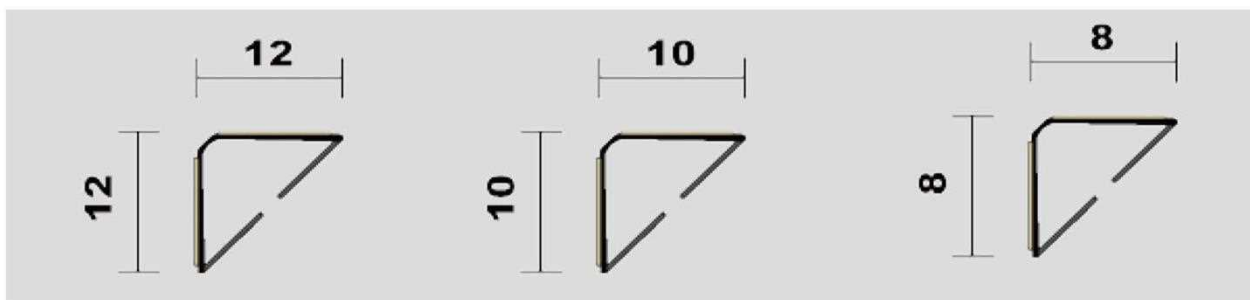

**RSR SERIES  
SILICONE SMOKE SEAL FOR DOORS**

RSR series smoke seal is manufactured of high temperature silicone rubber which is self-extinguishing. It can be used on doors where require smoke protection.

- Designed for tighter frames
- Demonstrates extremely low closing force
- Impervious to fungus and mildew
- Function: Seal gaps to prevent smoke weather dust
- Product comes with strong self-adhesive
- Length: 200m/roll and 2 rolls/carton

Color is optional



Windproof



Dustproof



Smokeproof

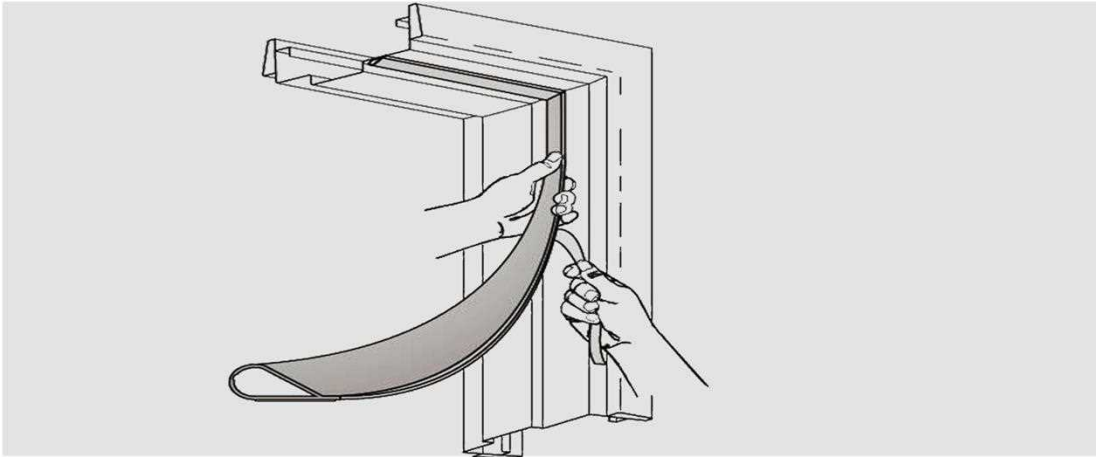

RSR is an adhesive-backed silicone gasket seal, it demonstrates extremely low closing force with excellent compression and the door latches easily.

RSR Series Silicone Smoke Seal for Doors



It can be installed on the perimeter of door opening to slow and prevent the passage of smoke weather sound and dirt.

**RSR SERIES  
SIZE CHART**

 <p style="text-align: center;">RSR-01</p>	 <p> <math>5/16''</math>              (7.9)  <math>7/16''</math>              (11.1)         </p> <p>             Low Closing Force Fin Seal              Stabilizer Flange              Adhesive Backing         </p>
---	---

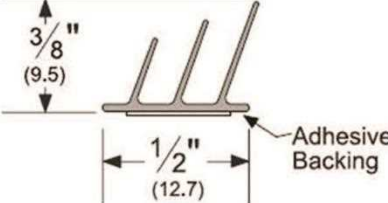
 <p style="text-align: center;">RSR-02</p>	 <p> <math>3/8''</math>              (9.5)  <math>1/2''</math>              (12.7)         </p> <p>Adhesive Backing</p>
---	---

 <p style="text-align: center;">RSR-03</p>	 <p> <math>1/4''</math>              (6.4)  <math>1/2''</math>              (12.7)         </p> <p>             Compression Bulb              Stabilizer Flange              Adhesive Backing         </p>
---	---

## RG SERIES SEALING SYSTEMS FOR MINIMALIST GLASS DOORS

This sealing systems for minimalist glass doors is beautifully designed and easy to install without traditional glue fixing and no additional sealant. Made of environmentally friendly materials with a long service life, creating a healthy life.

Easy installation  
Securely fixed without additional sealant  
Long service life  
Environmentally friendly materials  
Attractive design

Color is optional brown white black grey 

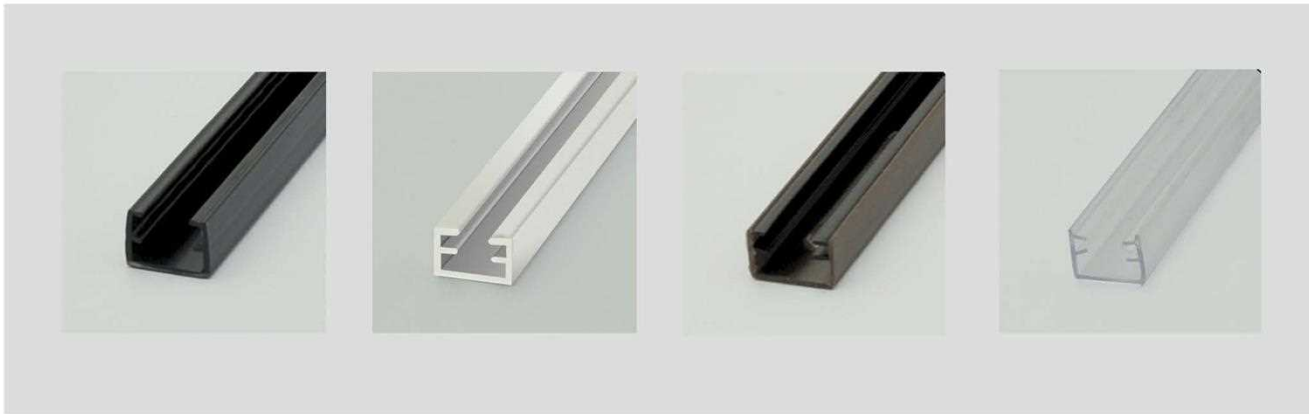

Innovative nesting design



Fits perfectly into a variety of decorating styles



RG SERIES  
SEALING SYSTEMS FOR MINIMALIST GLASS DOORS

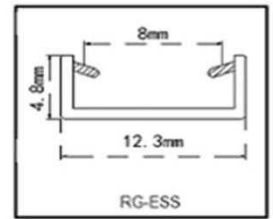
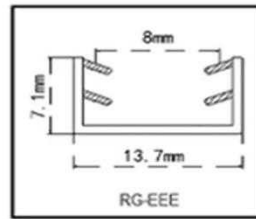
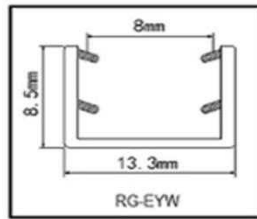
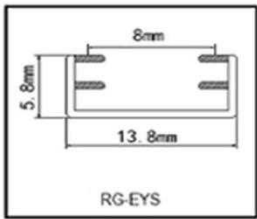
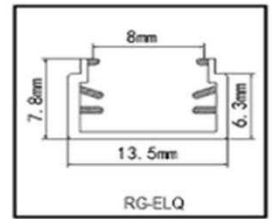
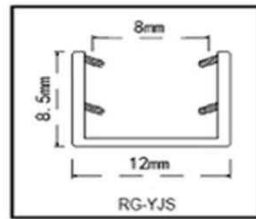
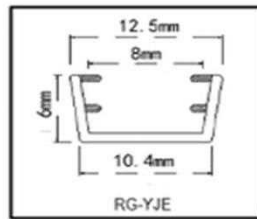
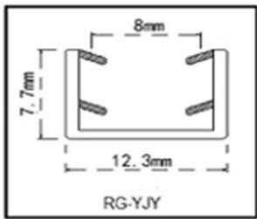
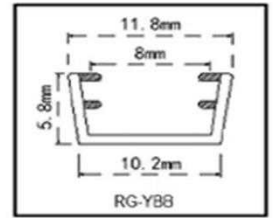
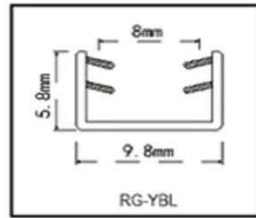
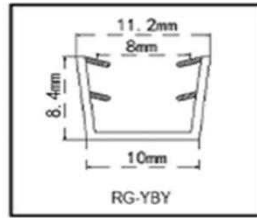
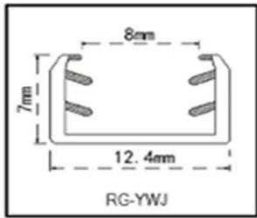
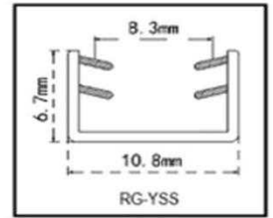
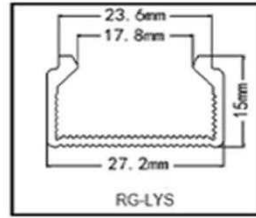
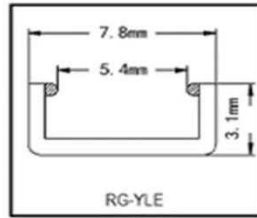
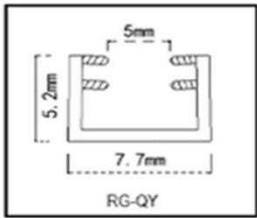
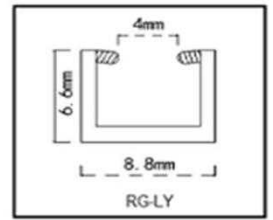
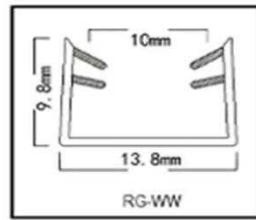
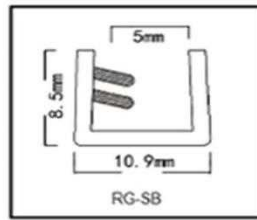
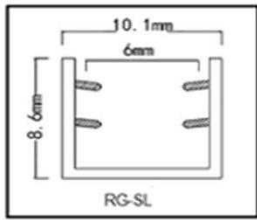
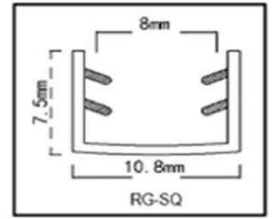
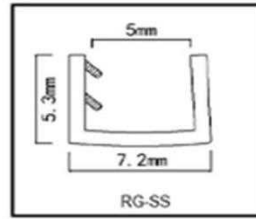
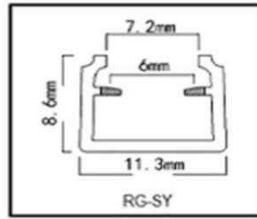
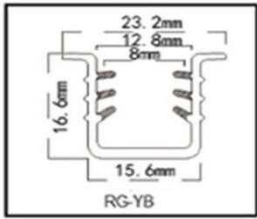

RG SERIES  
SEALING SYSTEMS FOR MINIMALIST GLASS DOORS

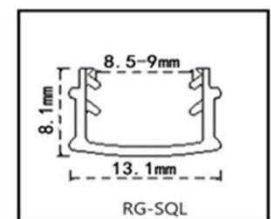
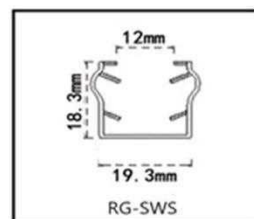
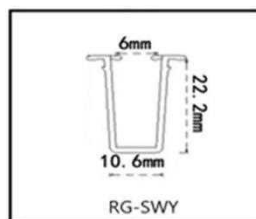
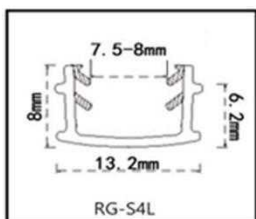
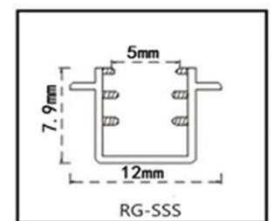
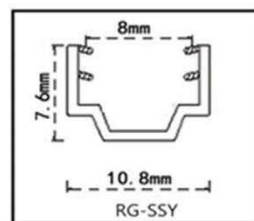
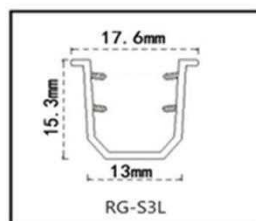
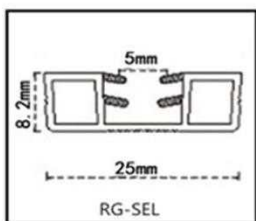
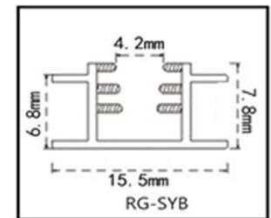
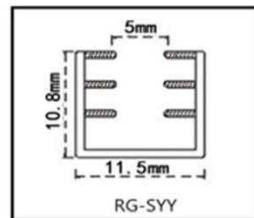
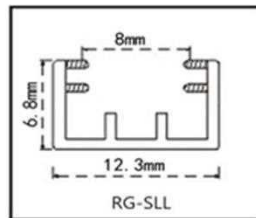
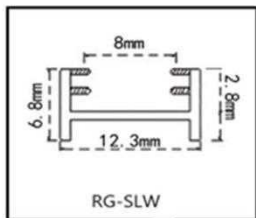
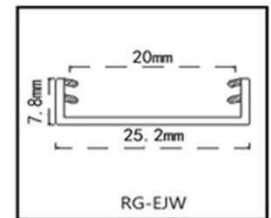
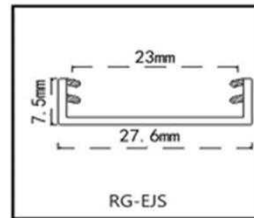
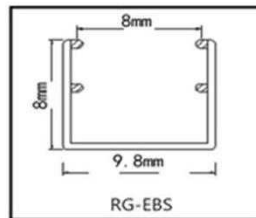
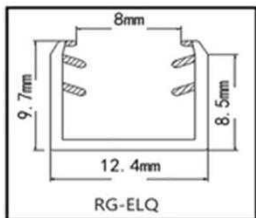
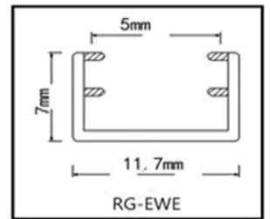
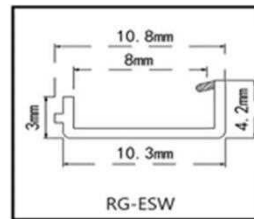
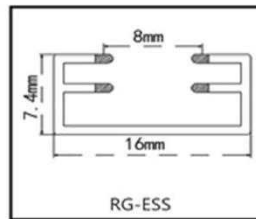
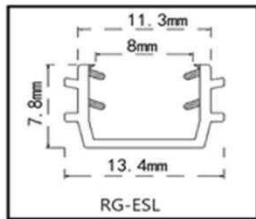
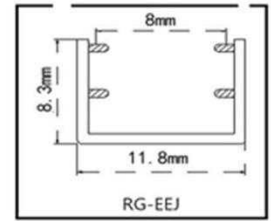
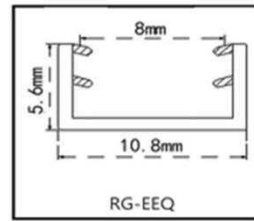
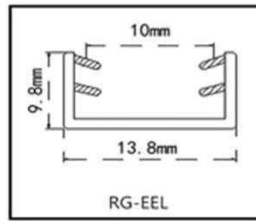
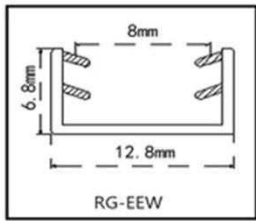

**RGDS-M SERIES  
MAGNETIC WATERPROOF SEAL FOR SHOWER DOOR**

This water stopper is used for shower glass door, made of hard and soft PVC material, waterproof and sealed. And the strip has a magnetic model, the magnet has a variety of colors to choose from, more integrated into the decorative style. It can be used for glass thickness of 5 6 8 10 12mm to meet different size options.

- High quality material, environmental health
- Hard plus soft PVC, strong waterproof performance
- Magnetic strip embedded, the door will not be popped open
- Multiple sizes and choices
- Can be integrated into different decoration styles

Color is optional brown white black grey









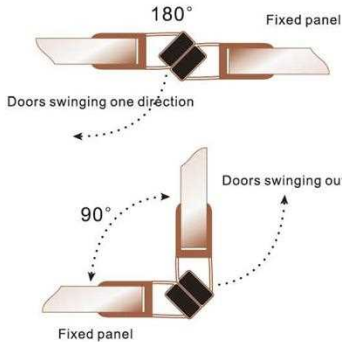
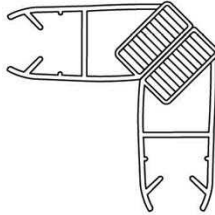

Suitable for multiple locations in the shower

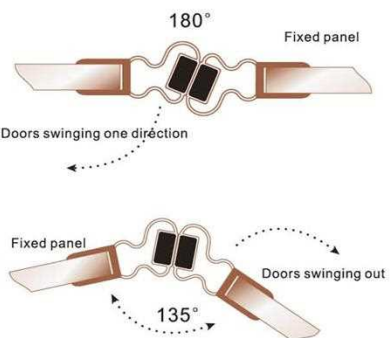
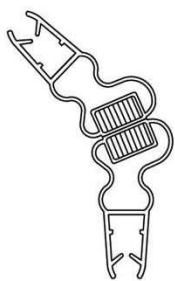

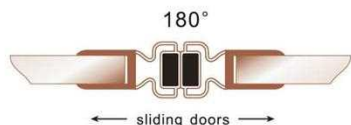
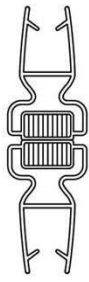





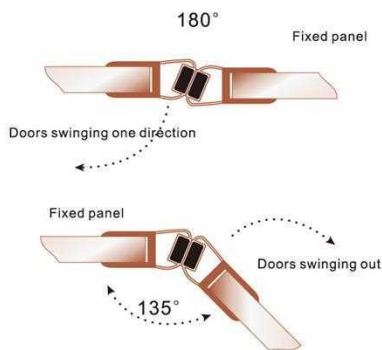

Incorporate a variety of decorating styles

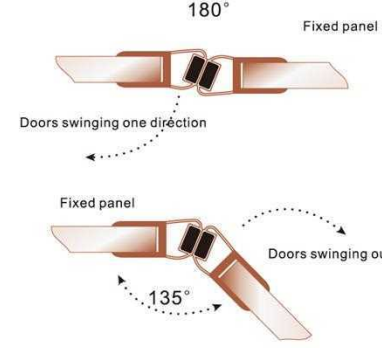

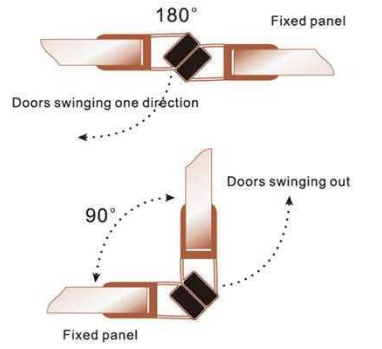



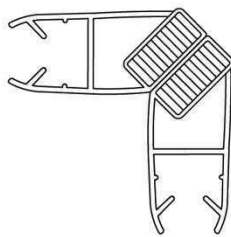

**RGDS-M SERIES  
MAGNETIC WATERPROOF SEAL FOR SHOWER DOOR**

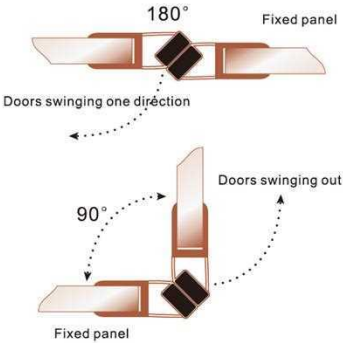
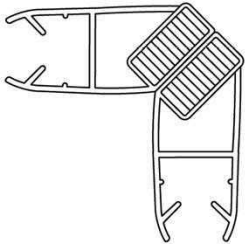
 <p><b>RGDS-M01</b></p>		 <p>5mm glass, 6mm glass 8mm glass, 10mm glass, 12mm glass</p>
 <p><b>RGDS-M02</b></p>		 <p>5mm glass, 6mm glass 8mm glass, 10mm glass, 12mm glass</p>
 <p><b>RGDS-M03</b></p>		 <p>5mm glass, 6mm glass 8mm glass, 10mm glass, 12mm glass</p>
 <p><b>RGDS-M04</b></p>		 <p>5mm glass, 6mm glass 8mm glass, 10mm glass, 12mm glass</p>

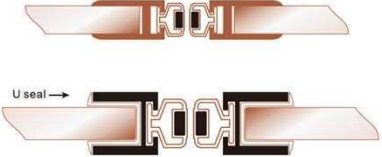
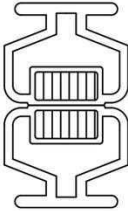

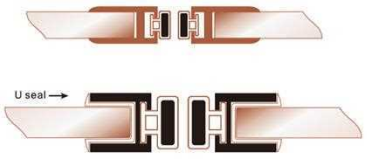
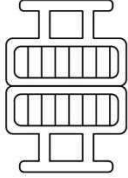



**RGDS-M SERIES  
MAGNETIC WATERPROOF SEAL FOR SHOWER DOOR**

 <p><b>RGDS-M05</b></p>		 <p>5mm glass, 6mm glass 8mm glass, 10mm glass, 12mm glass</p>
 <p><b>RGDS-M06</b></p>		 <p>5mm glass, 6mm glass 8mm glass, 10mm glass, 12mm glass</p>
 <p><b>RGDS-M07</b></p>		 <p>5mm glass, 6mm glass 8mm glass, 10mm glass, 12mm glass</p>
 <p><b>RGDS-M08</b></p>		 <p>5mm glass, 6mm glass 8mm glass, 10mm glass, 12mm glass</p>

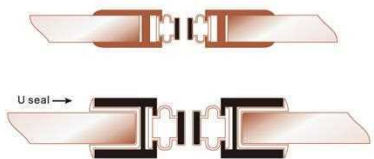
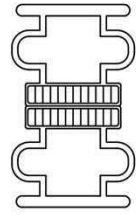
**RGDS-M SERIES  
MAGNETIC WATERPROOF SEAL FOR SHOWER DOOR**

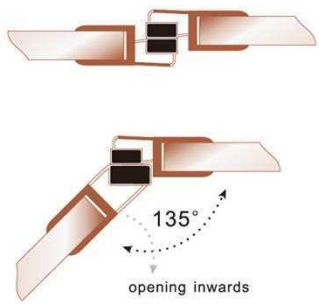
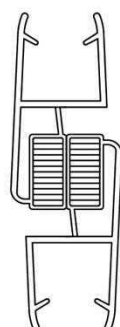
 <p><b>RGDS-M09</b></p>		 <p>5mm glass, 6mm glass 8mm glass, 10mm glass, 12mm glass</p>
 <p><b>RGDS-M10</b></p>		 <p>Suitable for Aluminium</p>
 <p><b>RGDS-M11</b></p>		 <p>Suitable for Aluminium</p>
 <p><b>RGDS-M12</b></p>		 <p>Suitable for Aluminium</p>

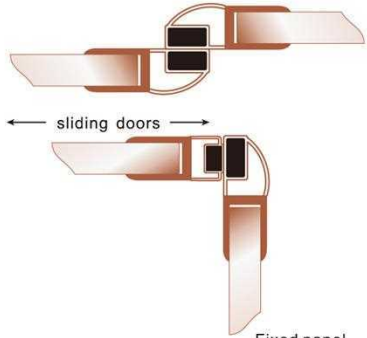
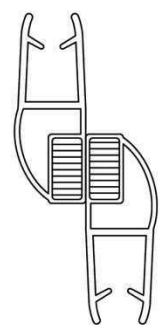
**RGDS-M SERIES  
MAGNETIC WATERPROOF SEAL FOR SHOWER DOOR**

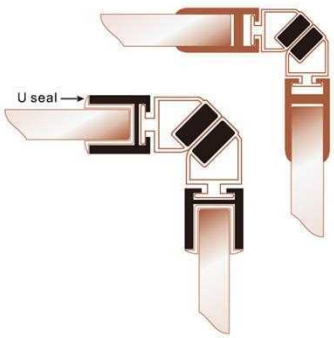
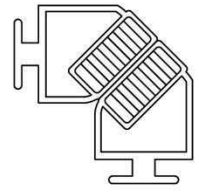





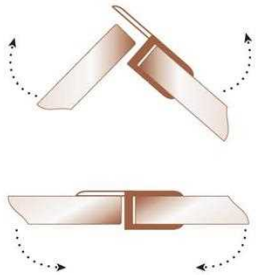

 <p><b>RGDS-M13</b></p>	 <p>U seal →</p>	 <p>Suitable for Aluminium</p>
 <p><b>RGDS-M14</b></p>	 <p>135° opening inwards</p>	 <p>5mm glass, 6mm glass 8mm glass, 10mm glass, 12mm glass</p>
 <p><b>RGDS-M15</b></p>	 <p>← sliding doors → Fixed panel</p>	 <p>5mm glass, 6mm glass 8mm glass, 10mm glass, 12mm glass</p>
 <p><b>RGDS-M16</b></p>	 <p>U seal →</p>	 <p>Suitable for Aluminium</p>

**RGDS-M SERIES  
MAGNETIC WATERPROOF SEAL FOR SHOWER DOOR**

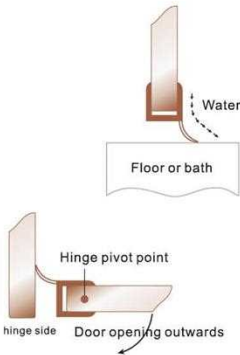
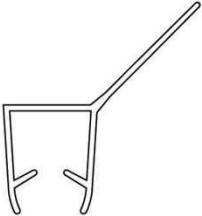
 <p><b>RGDS-M17</b></p>	 <p>U seal</p>	 <p>Suitable for Aluminium</p>
 <p><b>RGDS-M18</b></p>	 <p>Aluminium</p>	 <p>5mm glass, 6mm glass 8mm glass, 10mm glass, 12mm glass</p>
 <p><b>RGDS-M18</b></p>	 <p>Aluminium</p>	 <p>5mm glass, 6mm glass 8mm glass, 10mm glass, 12mm glass</p>

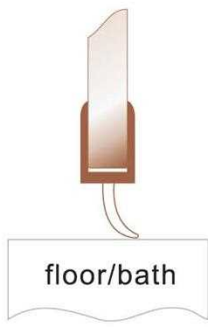
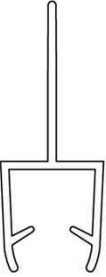

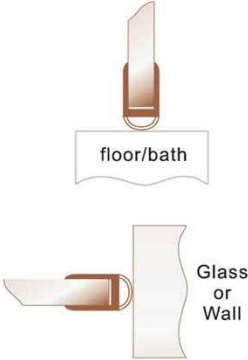





**RGDS SERIES  
WATERPROOF SEAL FOR SHOWER DOOR**

 <p><b>RGDS-01</b></p>		 <p>5mm glass, 6mm glass 8mm glass, 10mm glass, 12mm glass</p>
 <p><b>RGDS-02</b></p>	 <p>Water Floor or bath Hinge pivot point hinge side Door opening outwards</p>	 <p>5mm glass, 6mm glass 8mm glass, 10mm glass, 12mm glass</p>
 <p><b>RGDS-03</b></p>	 <p>floor/bath</p>	 <p>5mm glass, 6mm glass 8mm glass, 10mm glass, 12mm glass</p>
 <p><b>RGDS-04</b></p>	 <p>floor/bath Glass or Wall</p>	 <p>5mm glass, 6mm glass 8mm glass, 10mm glass, 12mm glass</p>

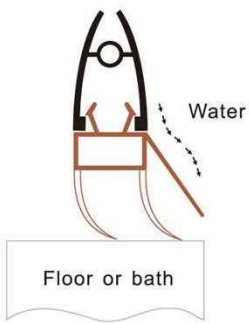
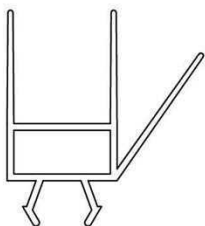
**RGDS SERIES  
WATERPROOF SEAL FOR SHOWER DOOR**

 <p><b>RGDS-05</b></p>	 <p>floor/bath</p>	 <p>5mm glass, 6mm glass 8mm glass, 10mm glass, 12mm glass</p>
 <p><b>RGDS-06</b></p>	 <p>← sliding doors →</p> <p>← sliding doors →</p>	 <p>5mm glass, 6mm glass 8mm glass, 10mm glass, 12mm glass</p>
 <p><b>RGDS-07</b></p>	 <p>Glass or wall</p>	 <p>5mm glass, 6mm glass 8mm glass, 10mm glass, 12mm glass</p>
 <p><b>RGDS-08</b></p>	 <p>Water</p> <p>floor/bath</p>	 <p>5mm glass, 6mm glass 8mm glass, 10mm glass, 12mm glass</p>

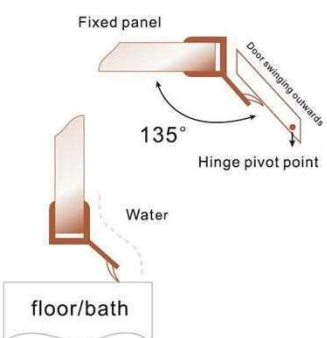
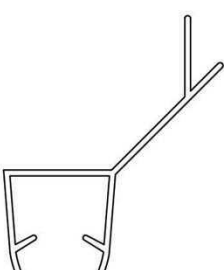
**RGDS SERIES  
WATERPROOF SEAL FOR SHOWER DOOR**

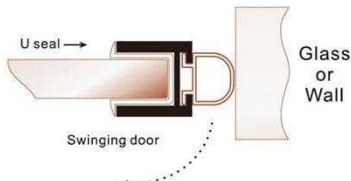
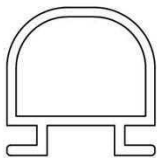
 <p><b>RGDS-09</b></p>	 <p>Floor or bath</p>	 <p>Suitable for Aluminium</p>
 <p><b>RGDS-10</b></p>	 <p>Floor or bath</p>	 <p>5mm glass, 6mm glass 8mm glass, 10mm glass, 12mm glass</p>
 <p><b>RGDS-11</b></p>	 <p>floor/bath</p>	 <p>5mm glass, 6mm glass 8mm glass, 10mm glass, 12mm glass</p>
 <p><b>RGDS-12</b></p>		 <p>5mm glass, 6mm glass 8mm glass, 10mm glass, 12mm glass</p>

**RGDS SERIES  
WATERPROOF SEAL FOR SHOWER DOOR**

 <p><b>RGDS-13</b></p>	 <p>Water</p> <p>Floor or bath</p>	 <p>5mm glass, 6mm glass 8mm glass, 10mm glass, 12mm glass</p>
 <p><b>RGDS-14</b></p>	 <p>Water</p> <p>Floor or bath</p>	 <p>5mm glass, 6mm glass 8mm glass, 10mm glass, 12mm glass</p>
 <p><b>RGDS-15</b></p>	 <p>floor/bath</p>	 <p>5mm glass, 6mm glass 8mm glass, 10mm glass, 12mm glass</p>
 <p><b>RGDS-16</b></p>	 <p>Water</p> <p>Floor or bath</p>	 <p>5mm glass, 6mm glass 8mm glass, 10mm glass, 12mm glass</p>

**RGDS SERIES  
WATERPROOF SEAL FOR SHOWER DOOR**

 <p><b>RGDS-17</b></p>	 <p>Water</p> <p>Floor or bath</p>	 <p>5mm glass, 6mm glass 8mm glass, 10mm glass, 12mm glass</p>
 <p><b>RGDS-18</b></p>		 <p>5mm glass, 6mm glass 8mm glass, 10mm glass, 12mm glass</p>
 <p><b>RGDS-19</b></p>	 <p>Water</p> <p>Floor or bath</p>	 <p>5mm glass, 6mm glass 8mm glass, 10mm glass, 12mm glass</p>

SEALS FOR ALUMINUM DOOR

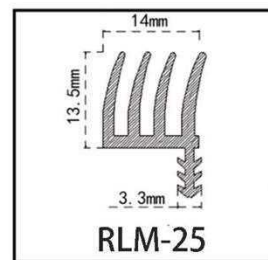
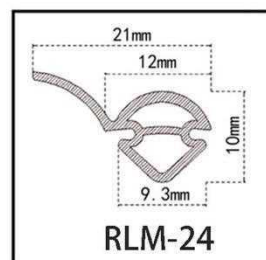
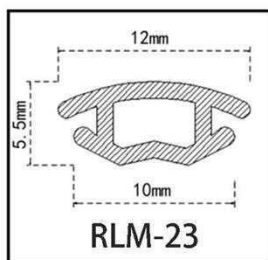
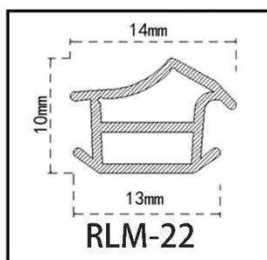
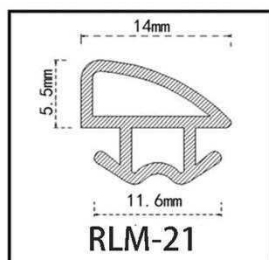
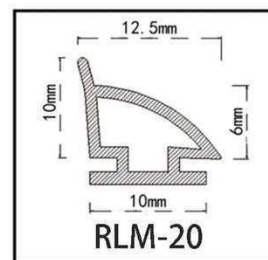
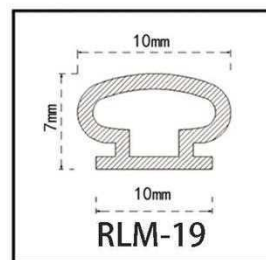
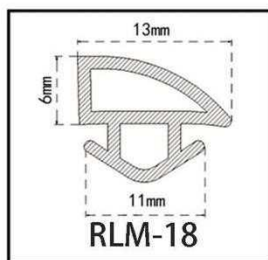
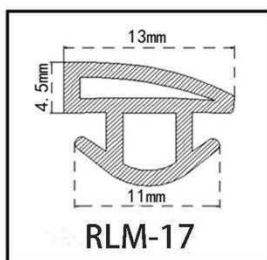
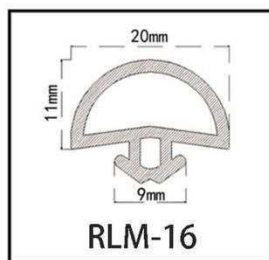
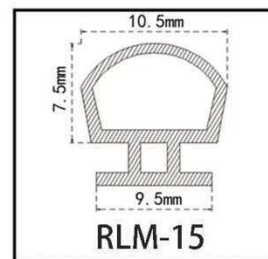
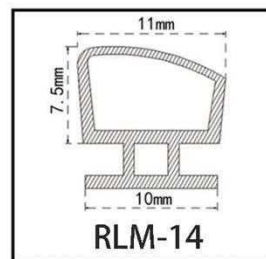
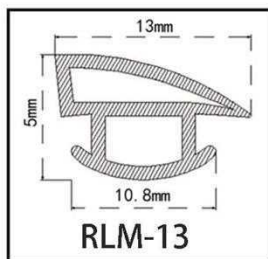
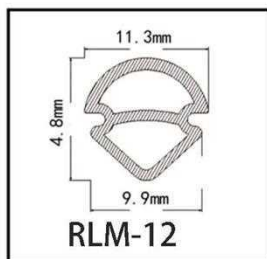
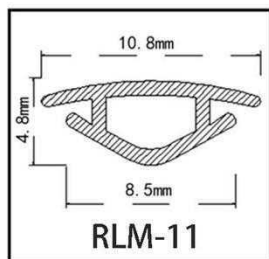
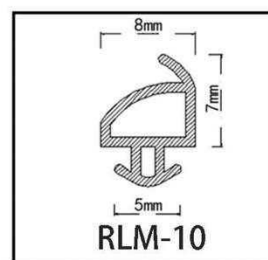
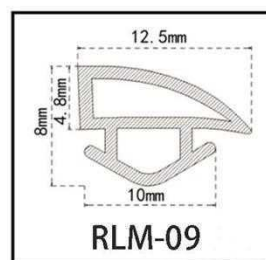
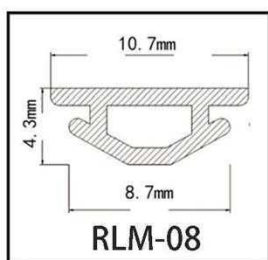
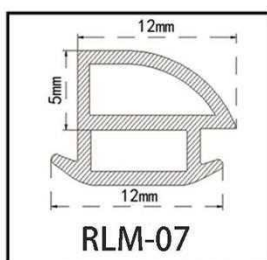
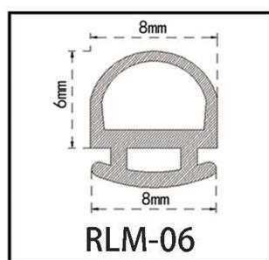
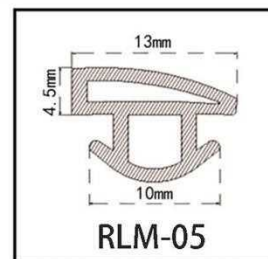
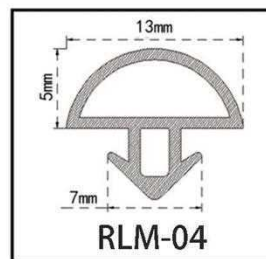
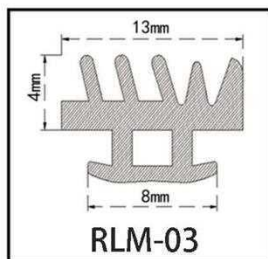
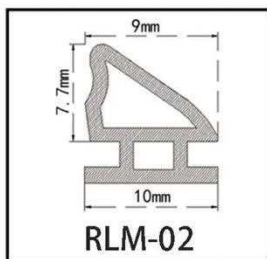
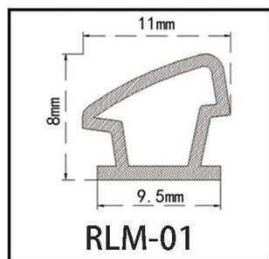

SEALS FOR ALUMINUM DOOR

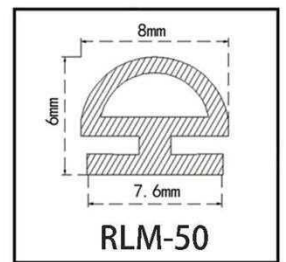
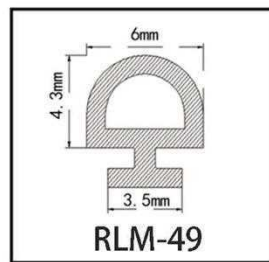
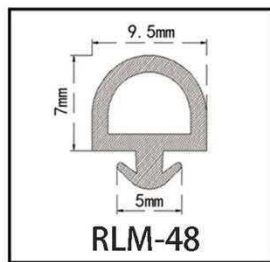
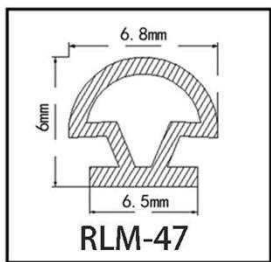
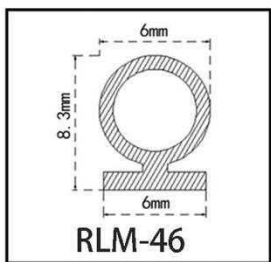
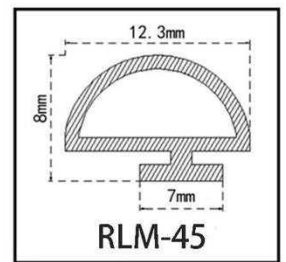
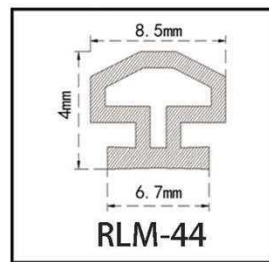
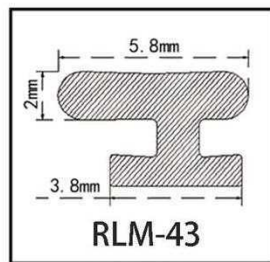
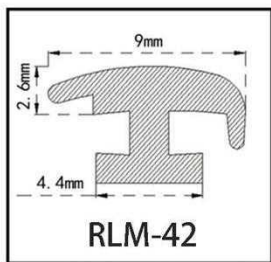
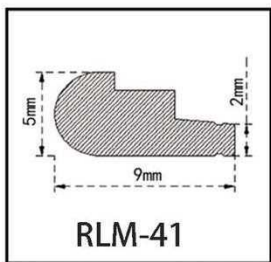
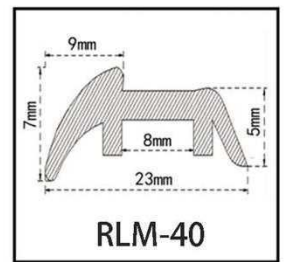
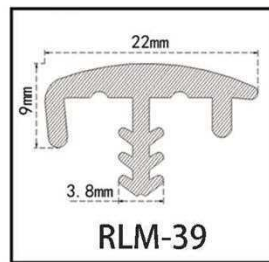
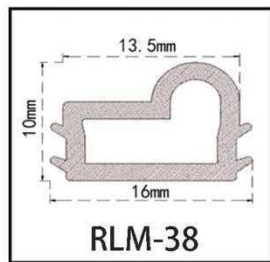
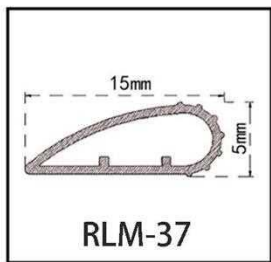
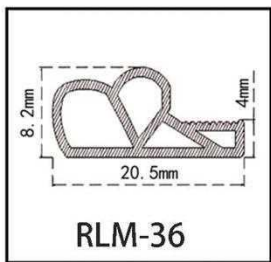
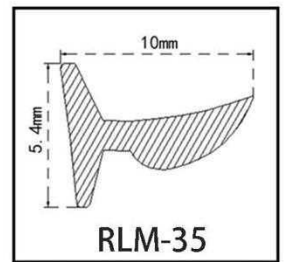
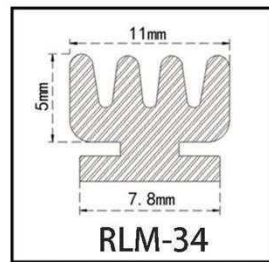
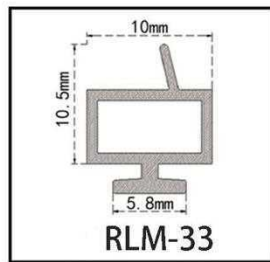
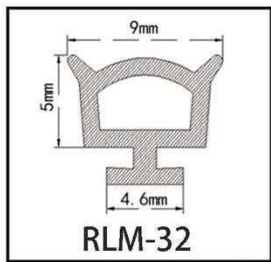
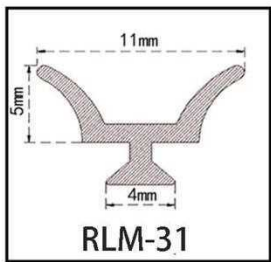
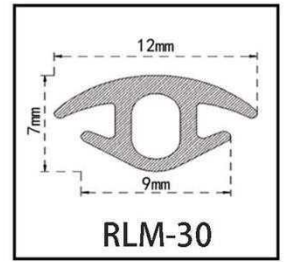
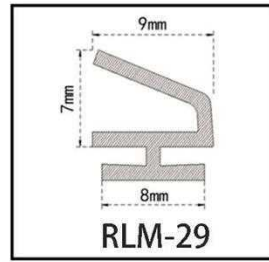
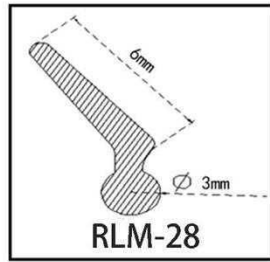
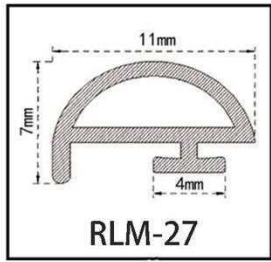
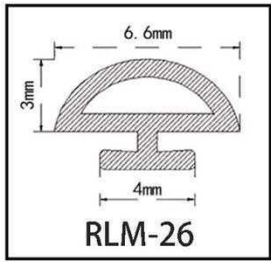

SEALS FOR ALUMINUM DOOR

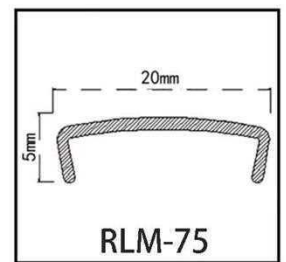
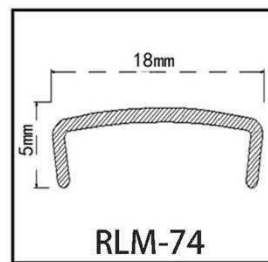
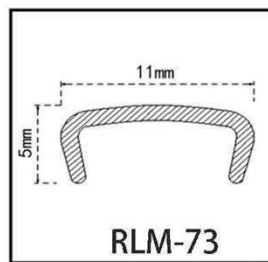
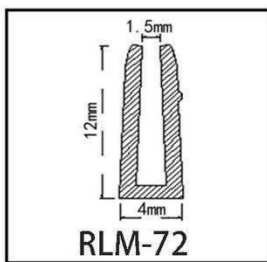
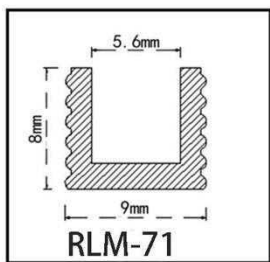
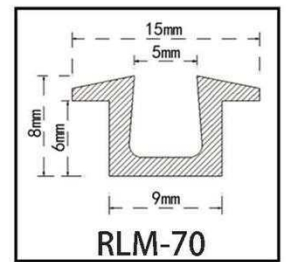
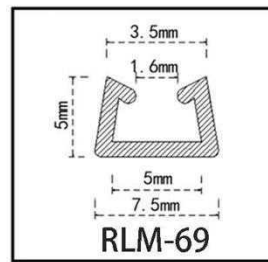
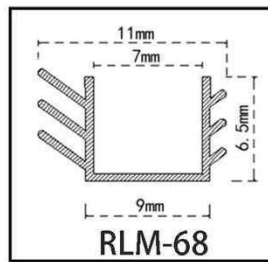
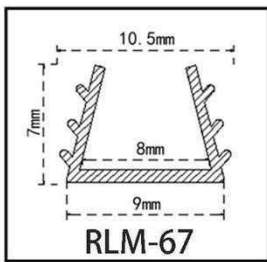
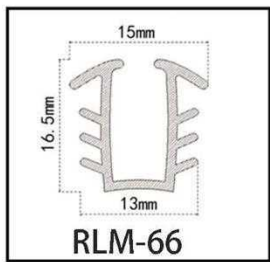
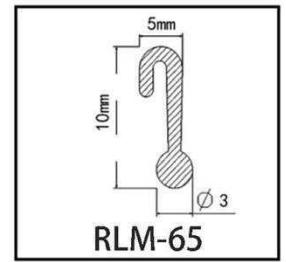
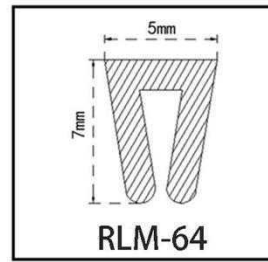
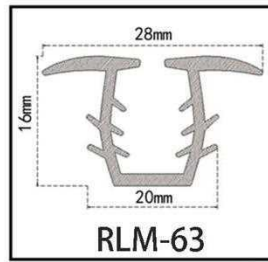
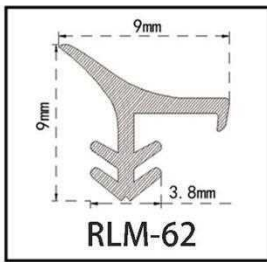
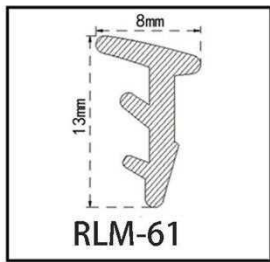
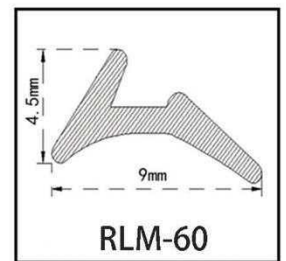
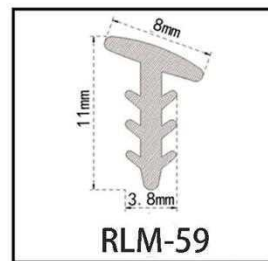
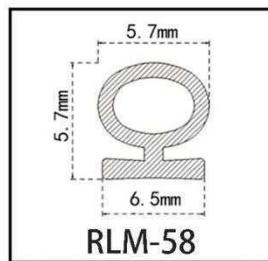
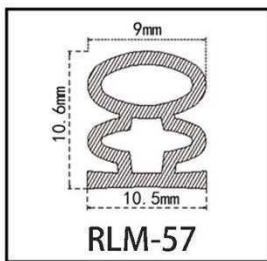
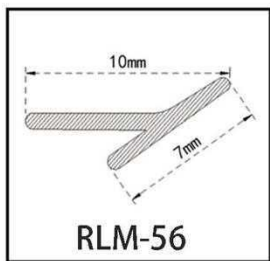
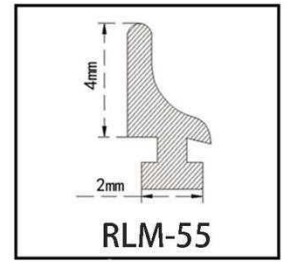
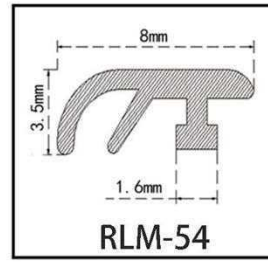
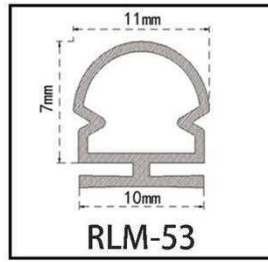
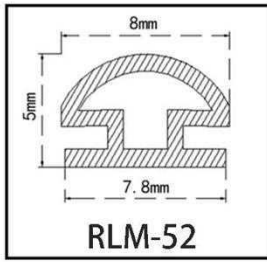
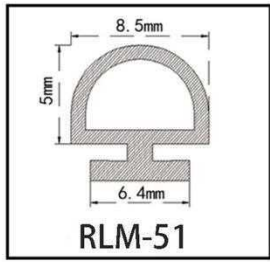



## ALUMINUM DOOR AND WINDOW ANTI-COVER ADHESIVE STRIP

This series of aluminum doors and windows cover rubber strip, using high elasticity TPE rubber material exquisite and become, due to good elasticity, moderate hardness and softness, easy to install and not easy to fall off, to solve the hard PVC cover size on the market is difficult to control, a little bit too big is not easy to install, small and card is not tight and easy to fall off, the scrap rate is high, is the aluminum doors and windows of the ideal supporting products.

Made of high elasticity TPE rubber material  
 Good elasticity, soft and hard, can effectively play its role  
 Easy to install, solving the problem of difficult to control the size of rigid PVC cover plate  
 Solve the problems of easy to fall off and high scrap rate

Color is optional brown white black grey

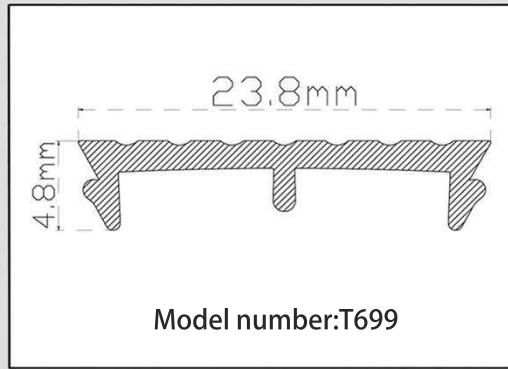
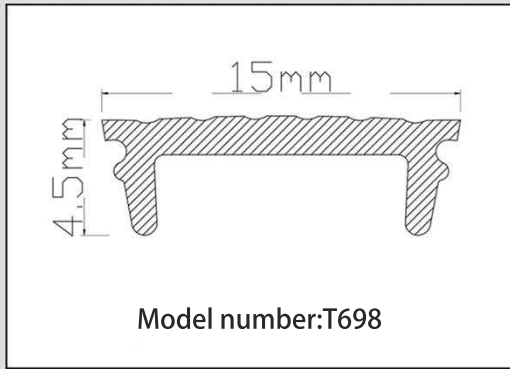

Suitable for window mounting,  
 good elasticity and not easy to fall off

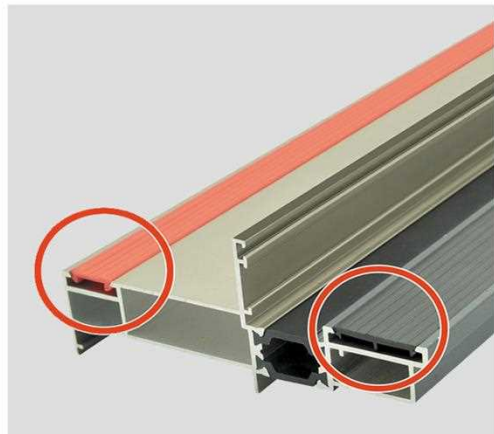

Ideal complementary products for  
 broken-bridge aluminum doors and windows

## SEALS FOR WARDROBE SLIDING DOOR

Seals for wardrobe sliding door comes with backing, easy to install. Can also be used in cabinets, glass cabinets and other places, can effectively play the role of anti-collision and can play a sealing role, is one of the best choice of home sealing strip. Magnetic strips are soft material, so when the sliding door is closed, it will not be popped open due to the magnetic force of the magnetic strips, and it also plays the role of anti-collision.

Soft magnetic strip for safety and anti-collision  
 Magnetism prevents the door from popping open when it is closed  
 Sealing effect at the same time  
 Self-adhesive backing, easy to install

Color is optional brown white black grey



Can also be used in cabinets, glass cabinets and other places

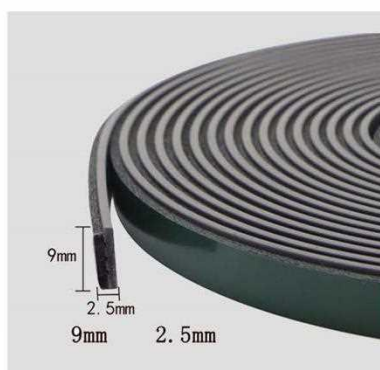

With soft magnetic strip, it can play the role of anti-collision at the same time of sealing. bounced open when it is closed

## SEALS FOR WARDROBE AND CABINET SWING DOOR

Seals for wardrobe and cabinet swing door is an excellent sealing material made of PVC, not only can effectively prevent dust, but also can be insect-proof, moisture-proof, anti-oil smoke, cabinet door sealing and so on. Easy to install, just measure the required length, cut the excess part, tear off the adhesive release paper and paste the dust seal to the side of the cabinet door.

Adhesive fixing part is hard PVC, sealing gap part is soft PVC

Dustproof, insect-proof

Moisture-proof, smoke-proof, and prevent the cabinet door from closing automatically

Excellent wear resistance, not easy to wear

Easy installation with strong self-adhesive

Colors are optional

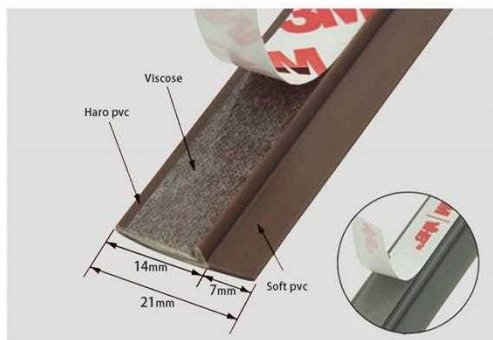

Measure the required length when installing, cut the excess part, and then



First Generation Dust Seal



Second Generation Dust Seal

SEALS FOR CUSTOMIZATION

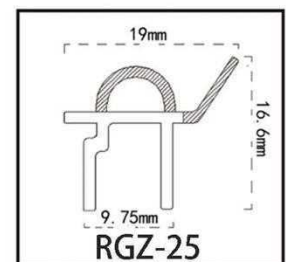
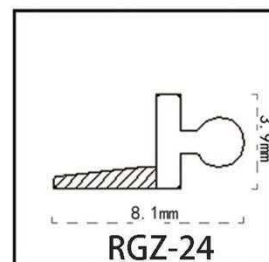
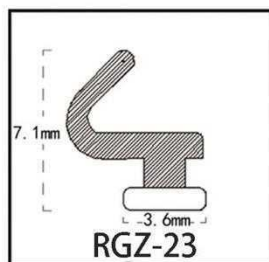
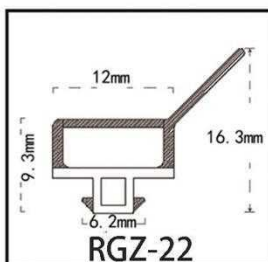
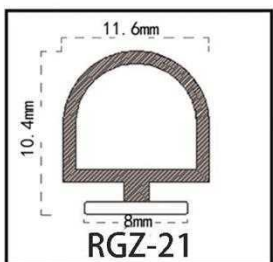
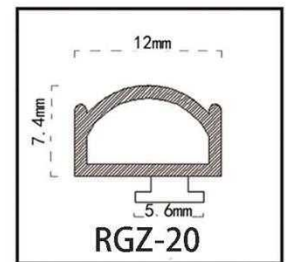
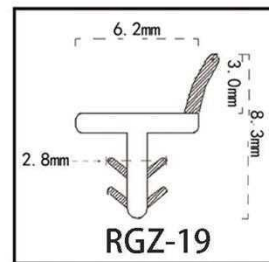
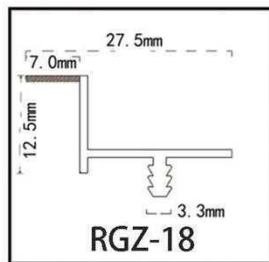
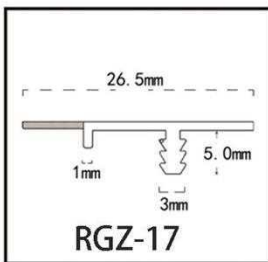
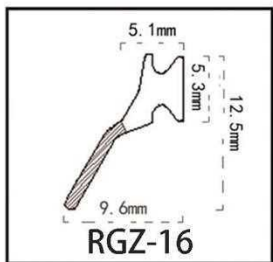
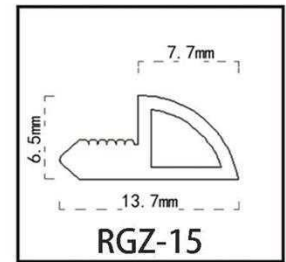
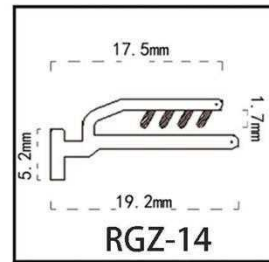
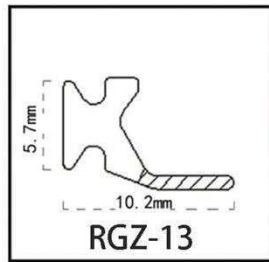
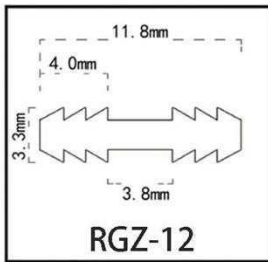
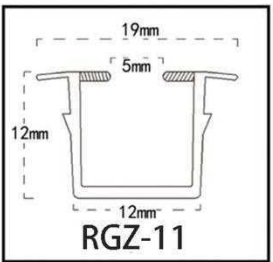
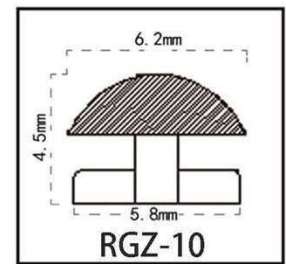
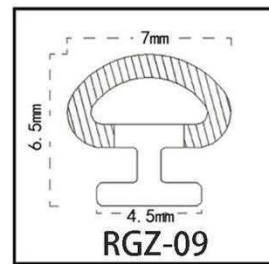
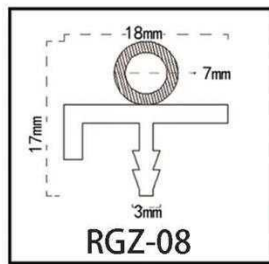
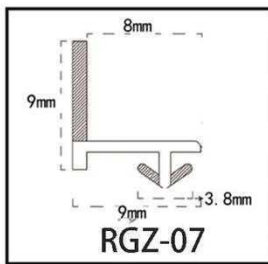
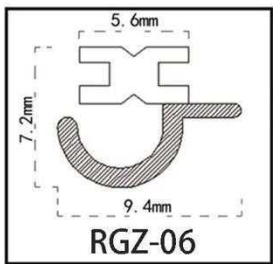
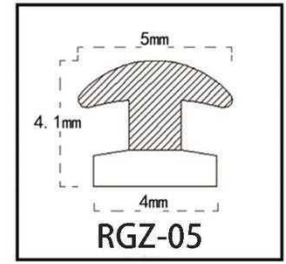
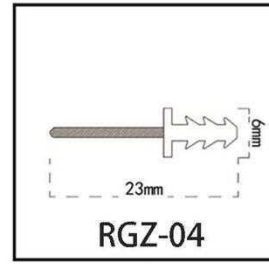
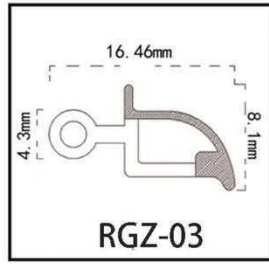
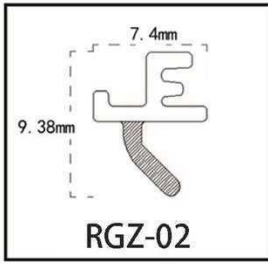
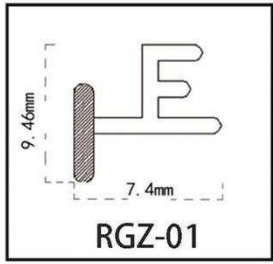

**SEALS FOR CUSTOMIZATION**

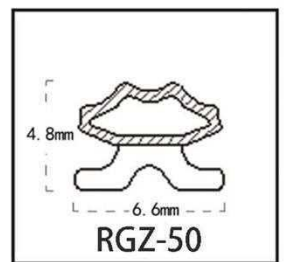
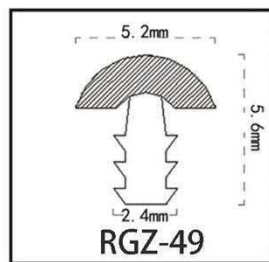
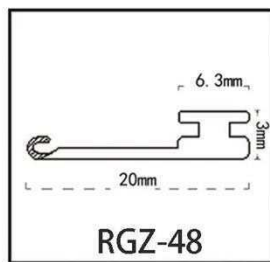
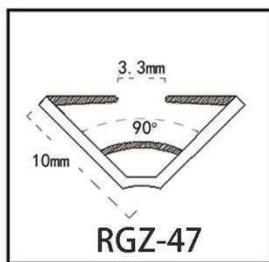
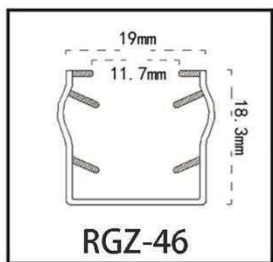
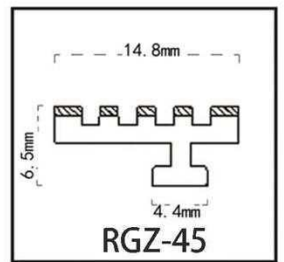
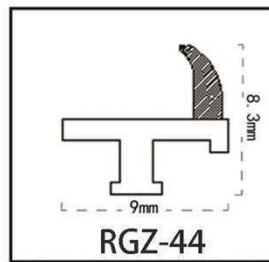
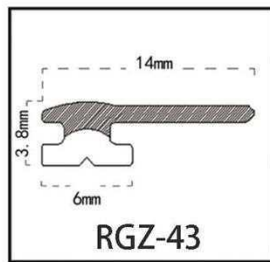
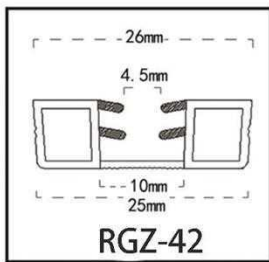
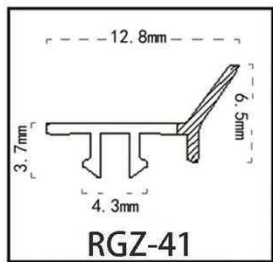
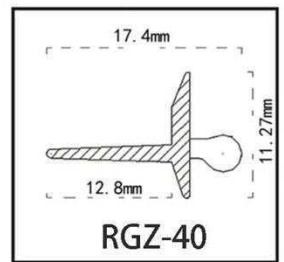
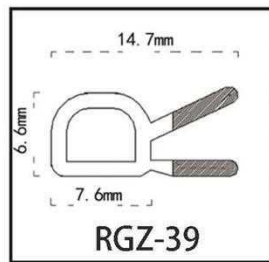
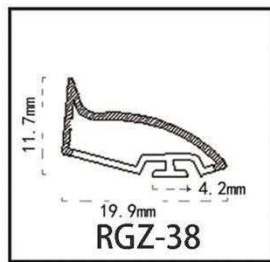
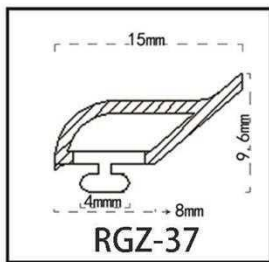
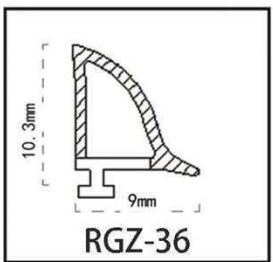
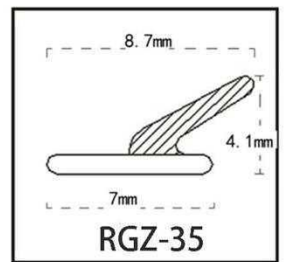
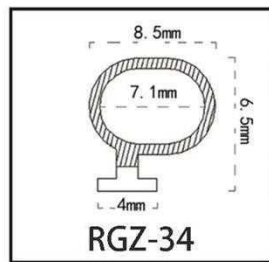
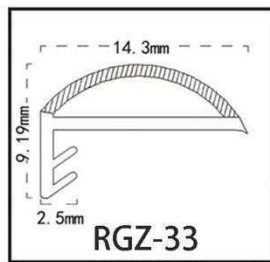
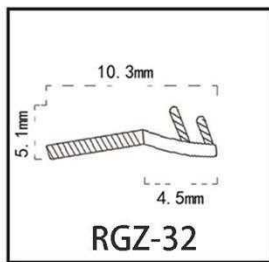
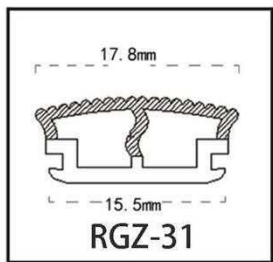
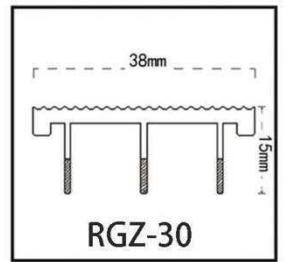
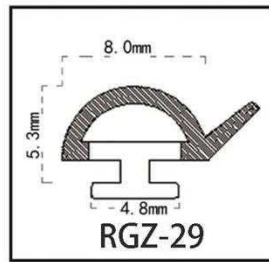
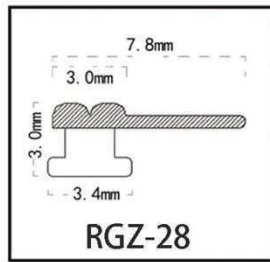
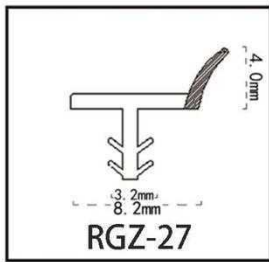
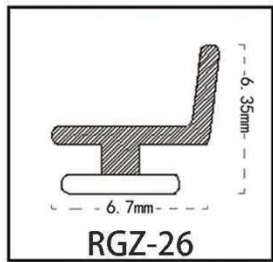

SEALS FOR CUSTOMIZATION

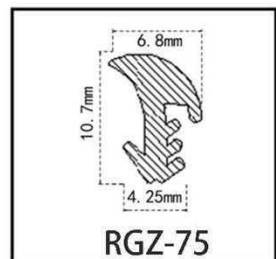
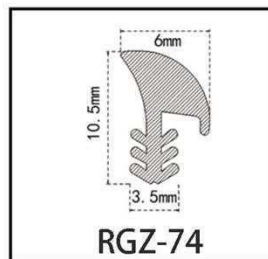
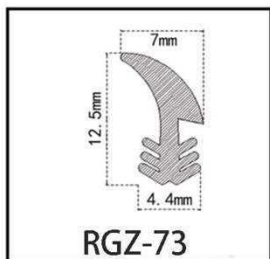
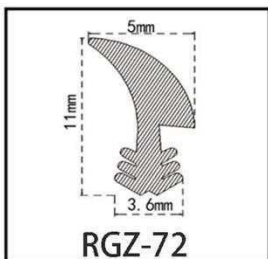
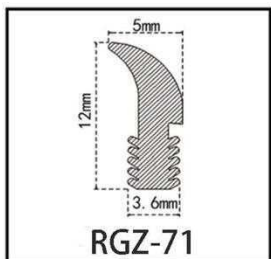
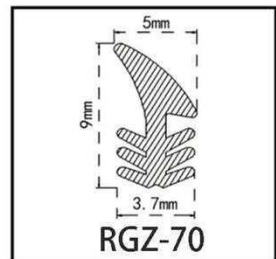
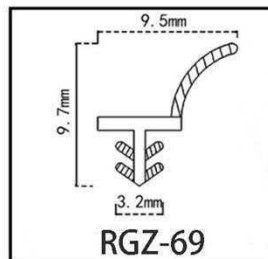
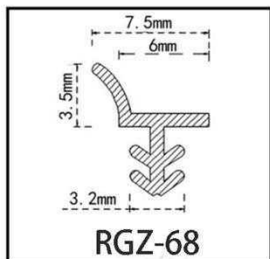
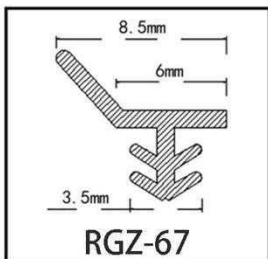
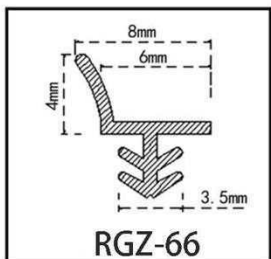
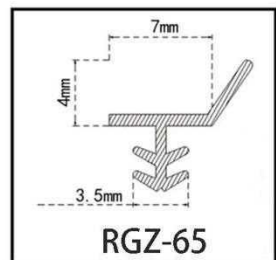
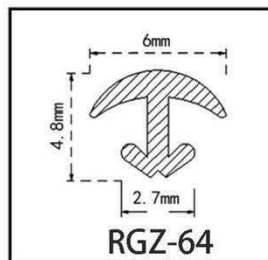
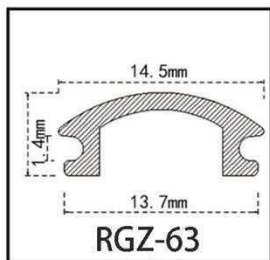
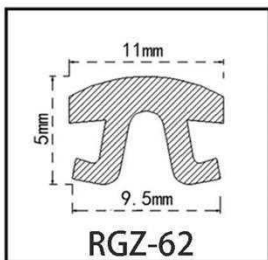
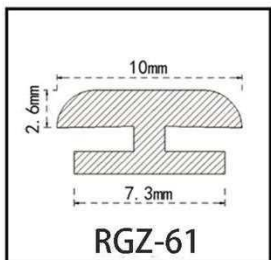
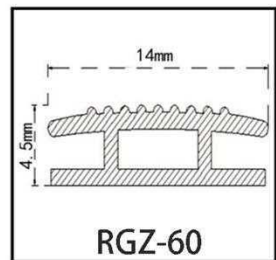
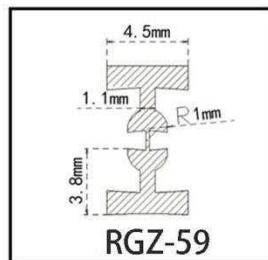
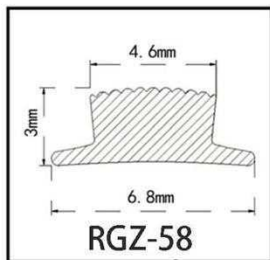
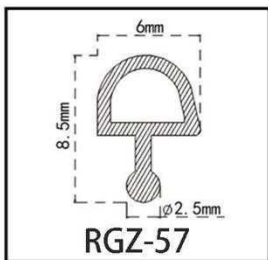
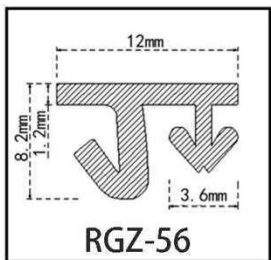
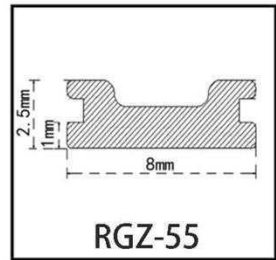
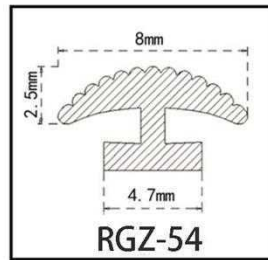
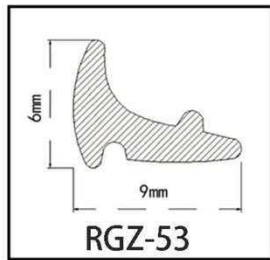
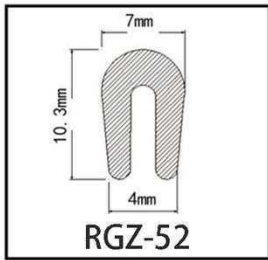
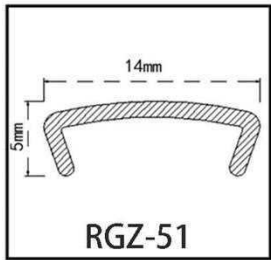

## SEALS FOR STEEL PURIFICATION DOOR BOTTOM

This steel purification door bottom seal has several styles and models to choose from, perfectly adapting to all size needs. The automatic lifting function returns to the intelligent life. Made of high-quality steel, it can insulate cold and heat, not only dustproof but also insect-proof. Sufficient thickness can also sound insulation and noise reduction.



Thermal insulation



Dust and insect repellent



Noise reduction

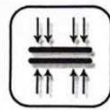

Automatic lifting

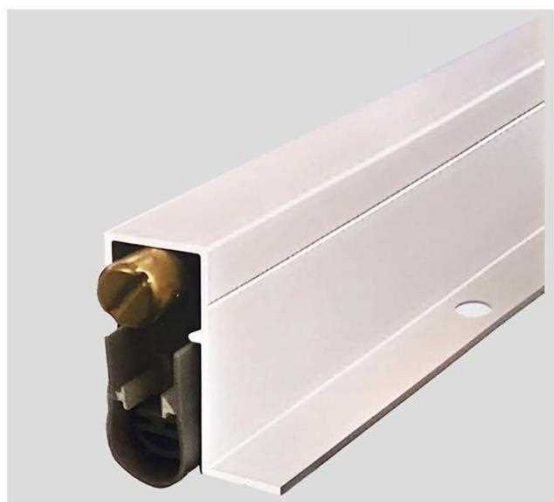
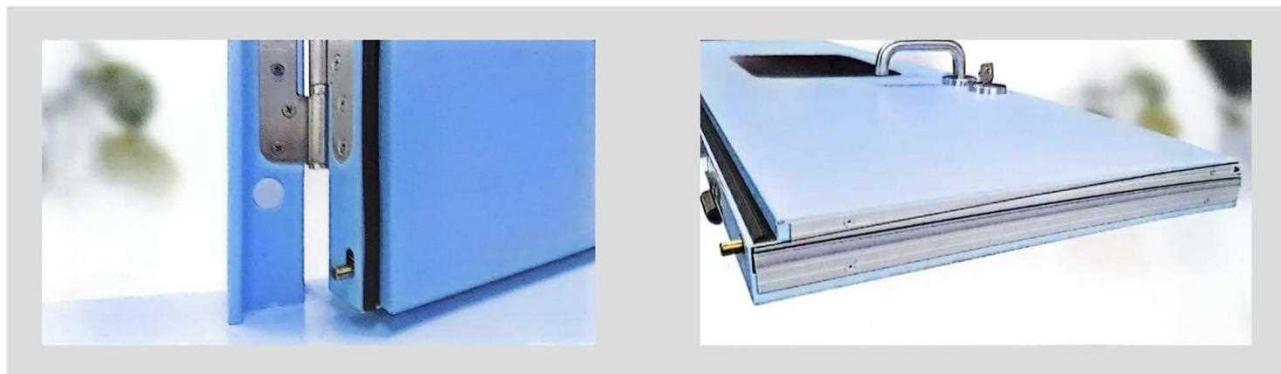



Made of high quality aluminum

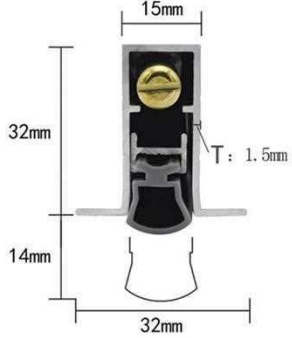
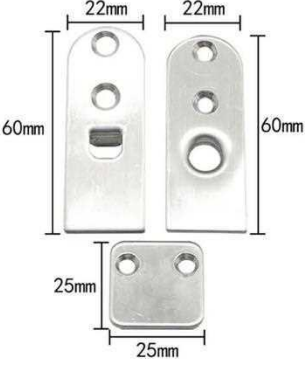

Sound and noise reduction

**SEALS FOR STEEL PURIFICATION DOOR BOTTOM**

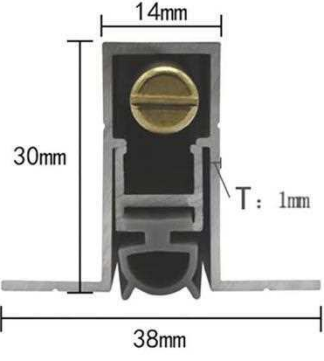
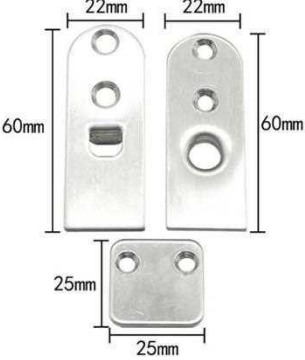

 <p><b>RMD-L02</b></p>			<ol style="list-style-type: none"> <li>1. Housing is 6063 aluminum with 304 stainless steel fasteners and screws.</li> <li>2. Silicone rubber seal as standard.</li> <li>3. Round brass heads are standard.</li> <li>4. Lengths: customized from 300 mm to 1500 mm.</li> <li>5. Normal lengths 800 mm, 915 mm and 1000 mm 800 mm can be cut to 700 mm 915 mm can be cut to 800 mm 1000 mm can be cut to 900 mm.</li> </ol>
--	---	--	--

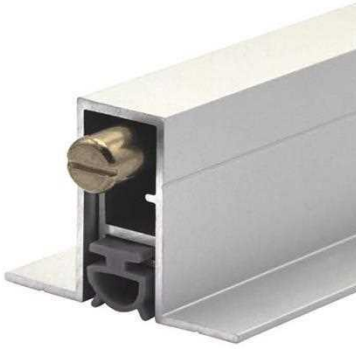
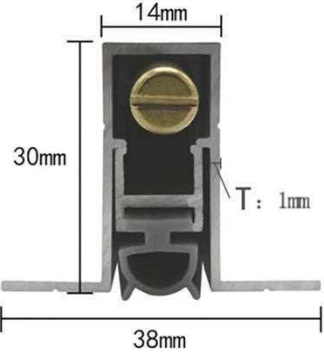
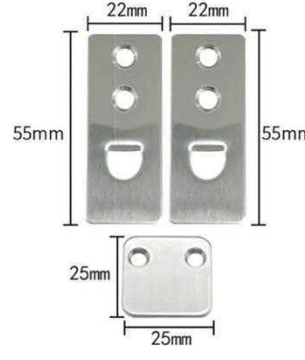
 <p><b>RMD-LY1</b></p>			<ol style="list-style-type: none"> <li>1. Housing is 6063 aluminum with 304 stainless steel fasteners and screws.</li> <li>2. Silicone rubber seal as standard.</li> <li>3. Round brass heads are standard.</li> <li>4. Lengths: customized from 300 mm to 1500 mm.</li> <li>5. Normal lengths 800 mm, 915 mm and 1000 mm 800 mm can be cut to 700 mm 915 mm can be cut to 800 mm 1000 mm can be cut to 900 mm.</li> </ol>
---	---	--	--



 <p><b>RMD-LS6</b></p>			<ol style="list-style-type: none"> <li>1. Housing is 6063 aluminum with 304 stainless steel fasteners and screws.</li> <li>2. TPE seals are used.</li> <li>3. Round brass heads are standard.</li> <li>4. Lengths: customized from 300 mm to 1500 mm.</li> <li>5. Normal lengths 800 mm, 915 mm and 1000 mm 800 mm can be cut to 700 mm 915 mm can be cut to 800 mm 1000 mm can be cut to 900 mm.</li> </ol>
--	---	--	--

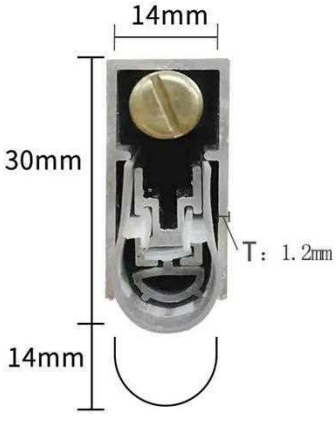

**SEALS FOR STEEL PURIFICATION DOOR BOTTOM**

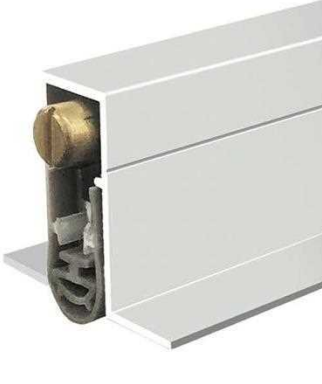
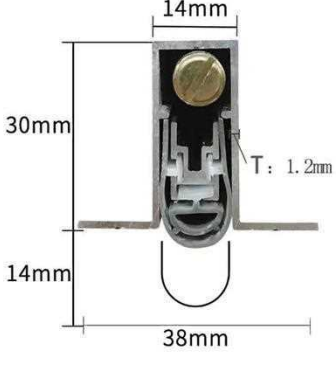
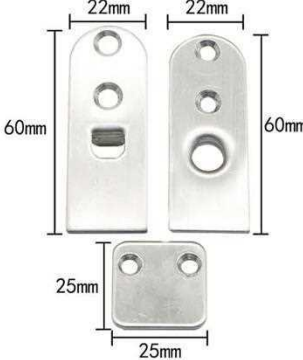
 <p><b>RMD-LW2</b></p>			<ol style="list-style-type: none"> <li>1. Housing is 6063 aluminum with 304 stainless steel fasteners and screws.</li> <li>2. TPE seals are used.</li> <li>3. Round brass heads are standard.</li> <li>4. Lengths: Custom lengths from 300 mm to 1500 mm are available.</li> <li>5. Normal lengths 800 mm, 915 mm and 1000 mm 800 mm can be cut to 700 mm 915 mm can be cut to 800 mm 1000 mm can be cut to 900 mm.</li> </ol>
--	---	--	--

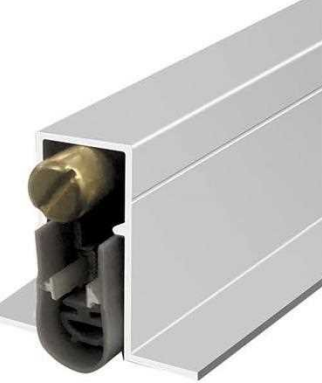
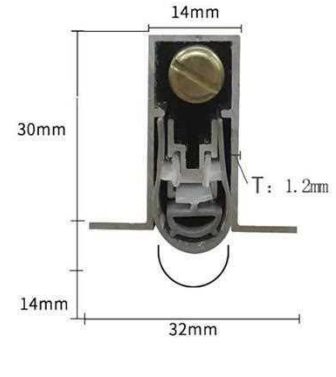
 <p><b>RMD-LW3</b></p>			<ol style="list-style-type: none"> <li>1. Housing is 6063 aluminum with 304 stainless steel fasteners and screws.</li> <li>2. TPE seals are used.</li> <li>3. Round brass heads are standard.</li> <li>4. Lengths: Custom lengths from 300 mm to 1500 mm are available.</li> <li>5. Normal lengths 800 mm, 915 mm and 1000 mm 800 mm can be cut to 700 mm 915 mm can be cut to 800 mm 1000 mm can be cut to 900 mm.</li> </ol>
---	---	--	--

 <p><b>RMD-LW5</b></p>			<ol style="list-style-type: none"> <li>1. Housing is 6063 aluminum with 304 stainless steel fasteners and screws.</li> <li>2. TPE seals are used.</li> <li>3. Round brass heads are standard.</li> <li>4. Lengths: Custom lengths from 300 mm to 1500 mm are available.</li> <li>5. Normal lengths 800 mm, 915 mm and 1000 mm 800 mm can be cut to 700 mm 915 mm can be cut to 800 mm 1000 mm can be cut to 900 mm.</li> </ol>
--	---	--	--

## SEALS FOR STEEL DOOR

This slot door frame sealing strip seal has several styles and models to choose from, perfectly adapting to all size needs. Made of high quality material, it can insulate cold and heat, suitable for the hospital environment, not only dustproof but also anti-insects. Sufficient thickness can also sound insulation and noise reduction, providing a quiet environment for hospital rooms.

Suitable for hospitals and other sterile environments  
 High quality material, environmental protection and health  
 Thickness guarantee, strong sealing performance  
 Various sizes and options  
 Effectively prevent dust from entering  
 Material can prevent insects



Thermal insulation



Dust and insect repellent



Noise reduction



Seam sealing



Various styles to choose from



Suitable for hospital dust and insect control

SEALS FOR STEEL DOOR

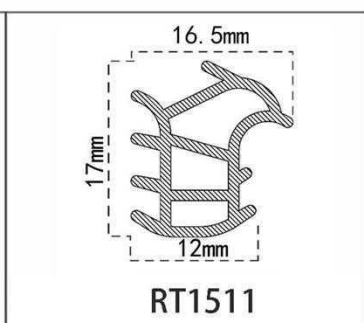
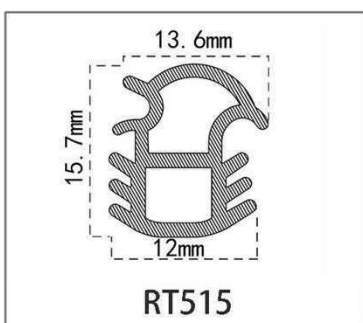
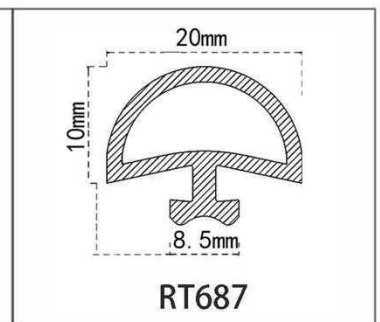
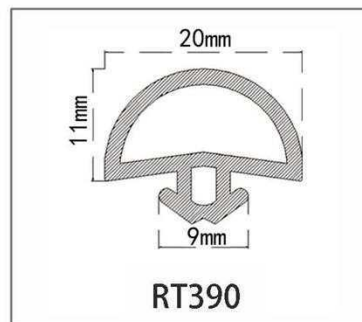
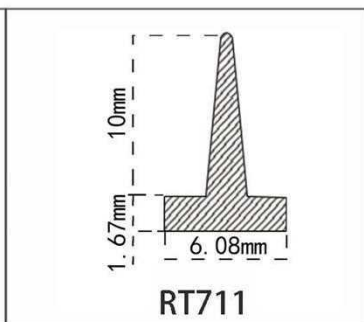
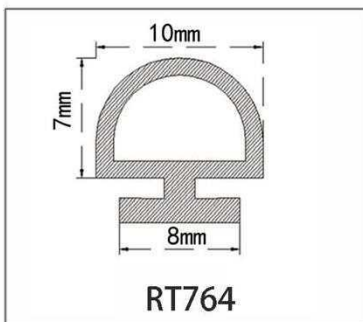
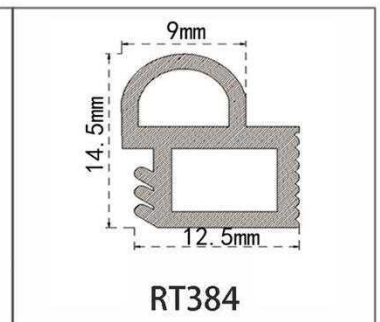
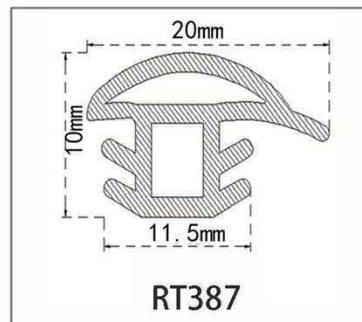
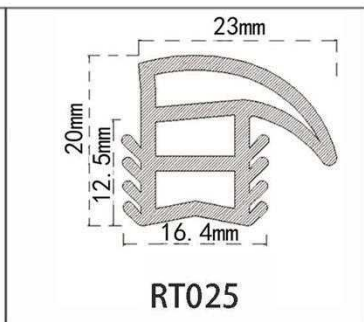
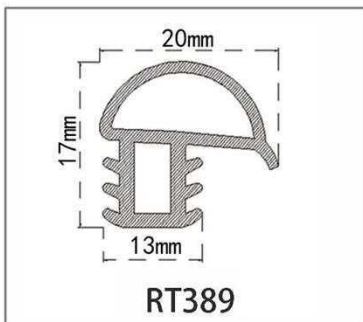
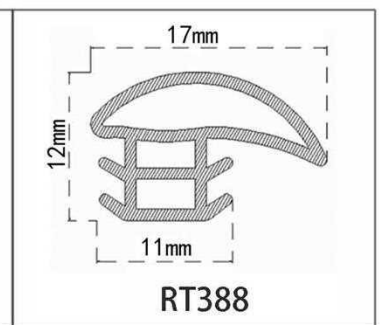
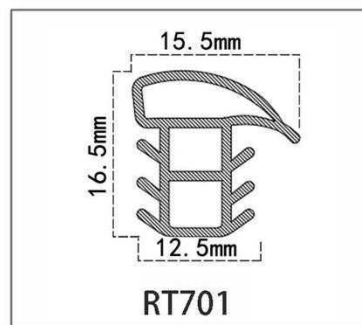
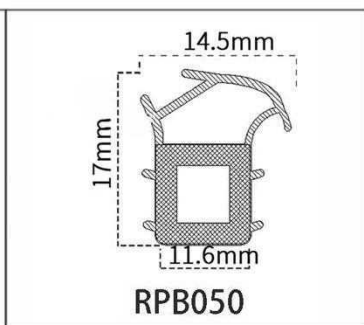
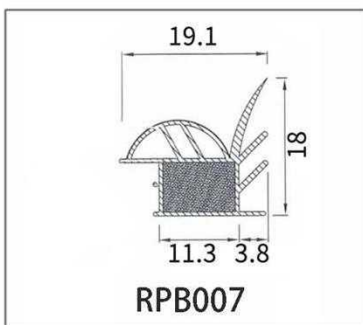

**SEALS FOR STEEL DOOR**

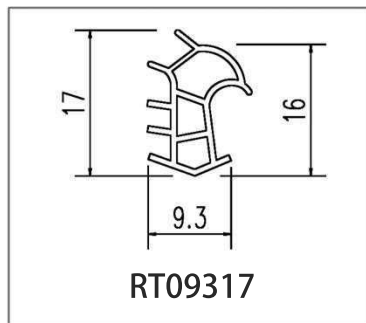
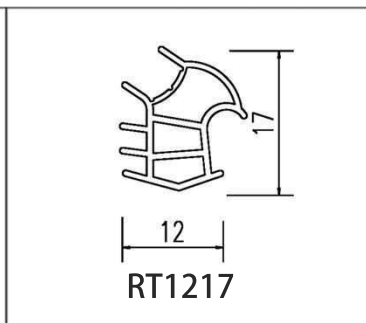
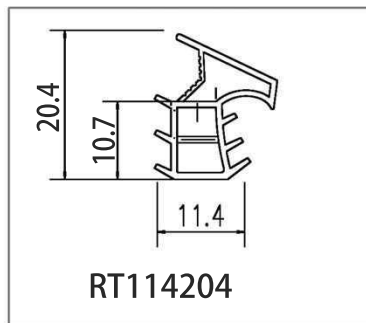
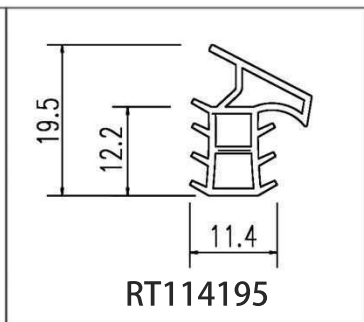
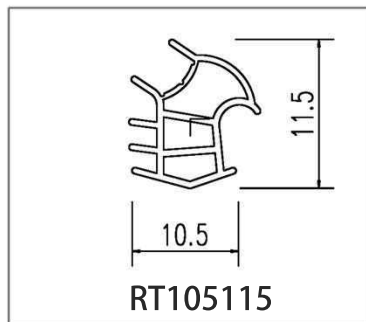
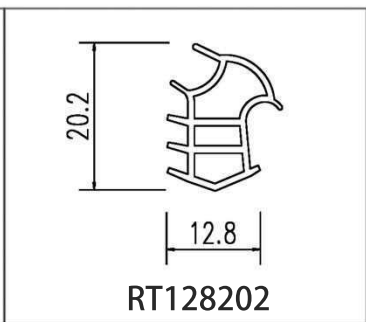
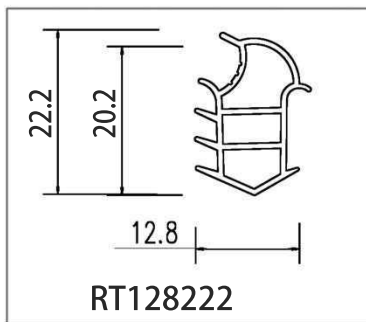
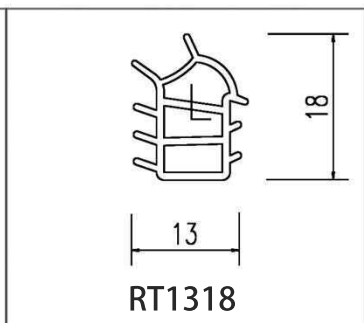
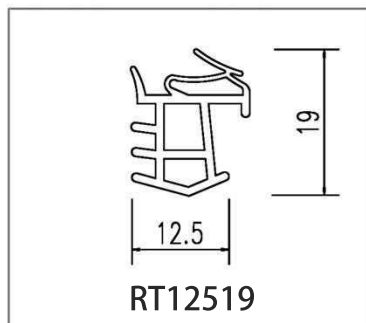
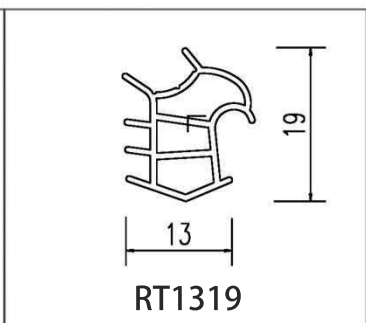
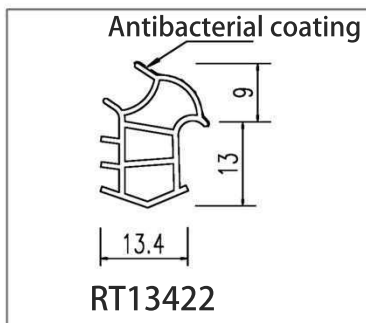
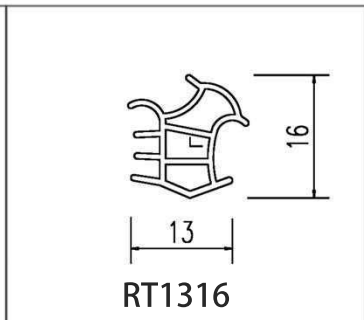
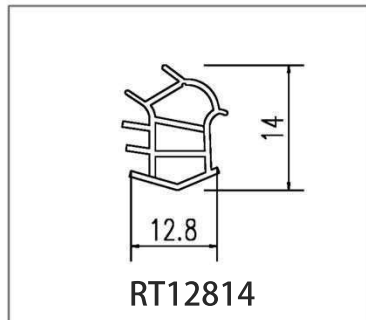
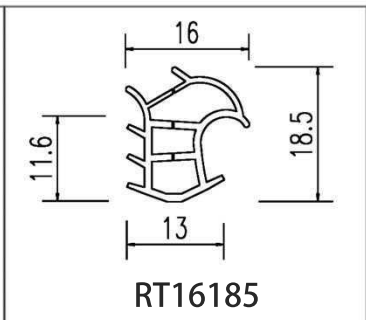
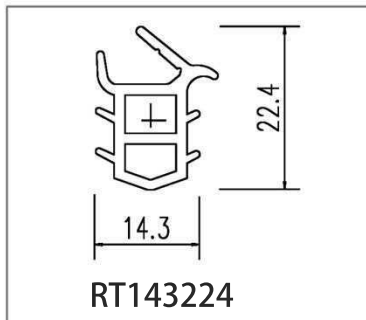



# Contact Us

We appreciate your interest in our products. For inquiries and further information please reach out to us through the following channels

☎ Tel./WhatsApp:0086-18845111091

🌐 Email: [sales@ressatech.com](mailto:sales@ressatech.com)

✉ Website: [www.ressaseal.com](http://www.ressaseal.com)

**Follow us on social media for the latest product updates!**

Facebook: <https://www.facebook.com/ressaseal>

Youtube: <https://www.youtube.com/@Ressaintumescentseal>

LinkedIn: <https://www.linkedin.com/company/ressaintumescentseal>

Instagram: <https://www.instagram.com/ressaseal/>

Twitter: <https://x.com/ressaseal>

pinterest: <https://www.pinterest.com/ressaintumescentseal/>

Tiktok: <https://www.tiktok.com/@intumescentsealressa>

We look forward to assisting you!